

NRA PRECISION AIR RIFLE POSITION RULES

REVISED JANUARY, 2012

NATIONAL RIFLE ASSOCIATION Official Rules for Precision Air Rifle Position Matches

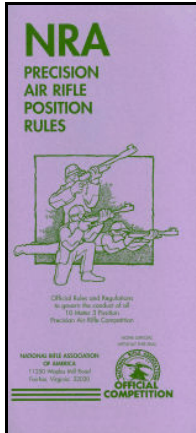

These rules establish uniform standards for NRA sanctioned Precision Air Rifle Position. Where alternatives are shown, the least restrictive conditions apply unless the tournament program sets forth limitations. The rules do not apply to International Shooting Union type competition. They supersede all earlier editions and remain in effect until specifically superseded.

Tournament sponsors may not alter these rules. If sponsors require additional rules for special conditions, the additions must be fully set forth in the program for the competition concerned.

The arrangement and rule numbering systems are such that corresponding rules for other types of NRA competition are correspondingly located and numbered in the Rule Books for those competitions. Gaps in the sequence of rule numbers result from there being a rule in one or more of the other Rule Books that does not apply in this book.

Recommendations for rule changes may be forwarded to the Air Gun Committee in care of the National Rifle Association.

NOTE: Rules in which major changes have been made for the current year are marked: ● (1.1). [Click here to see all changes since the last printing of this rule book.](#)

Click on the Section number or title to go to that Section.

Sec 1	NRA Competitions	Sec 12	Team Officer's Duties & Position
Sec 2	Eligibility of Competitors	Sec 13	Physically Disabled Shooters
Sec 3	Equipment & Ammunition	Sec 14	Scoring & Marking
Sec 4	Targets	Sec 15	Decision of Ties
Sec 5	Positions	Sec 16	Challenges & Protests
Sec 6	Range Standards	Sec 17	National Records
Sec 7	Courses of Fire	Sec 18	Competitor's Duties & Responsibilities
Sec 8	Time Limits	Sec 19	National Classifications
Sec 9	Competition Regulations & Range Operations	Sec 20	NRA Official Referee
Sec 10	Range Control & Commands		Illustrations
Sec 11	Tournament Officials		Appendix

1.NRA COMPETITION

1.0 NRA Competition - Competition which must be authorized in advance of firing by the Nation Rifle Association. The program, range facilities and officials must comply with standards established by the NRA.

1.1 Sanctioned Tournament - A sanctioned tournament is a series of matches covered by an Official Program. Such matches may be all individual matches, all team matches or a combination of both which must be conducted by an NRA affiliated club or organization. They may all be fired matches or a combination of fired and aggregate matches. A tournament may be conducted on one day, successive days, or may provide for intervening days between portions of the tournament, such as tournaments programmed for more than one weekend.

1.2 Authorization - Before being publicized in programs or otherwise, the sponsoring organization of each type of competition mentioned in Rule 1.6 shall have agreed to comply with the current regulations for such competition, and shall have received notice from the NRA that the application for competition has been authorized.

1.3 Rules -The local sponsor of each type of competition must agree to conduct the authorized competition according to NRA Rules, except as these Rules have been modified by the NRA in the General Regulations for that type of competition.

1.4 General Regulations - The local sponsor of each type of competition must agree to comply with the General Regulations published by the NRA for the competition concerned. The General Regulations may be found in the back of this book. See Appendix.

1.5 Refusal or Withdrawal of NRA Authorization - The NRA may refuse to authorize or may withdraw its authorization for any competition which cannot, or does not, comply with the requirements for that competition.

● **1.6 Types of Tournament** – The types of tournaments listed below are those which are sanctioned by the NRA in its competitive shooting program.

- (b) International Matches – Arranged by the NRA with the recognized national shooting organization(s) of the countries concerned. The Officials thereof are appointed by the NRA.
- (c) National Championships – Organized by the NRA, and in some cases in conjunction with the Civilian Marksmanship Program (CMP), to form the National Matches. The Officials thereof are appointed by the NRA, in some circumstances in cooperation with the CMP. These will be Registered Tournaments.
- (d) Sectional Championships – Arranged by the NRA and a local sponsoring organization.
- (e) State Championships – Annual tournaments authorized and/or conducted by State Rifle and/or Pistol Associations affiliated with the NRA. Such State Associations may, if desired, authorize local organizations to sponsor and conduct State Championships. In states where there is no NRA affiliated State Association, The NRA may authorize a local organization to sponsor and conduct the State Championship.
- (f) Registered Tournaments – National Records may only be established in Registered Tournaments (Rule 17.1). Match Sponsors may require all competitors to be NRA members if specified in the program.
- (g) Approved Tournaments – May be authorized by the NRA after application has been filed by the local organization which will act as the sponsor. Applications forms are available from the NRA on request.
- (h) Sanctioned Leagues – (shoulder-to-shoulder or postal) May be authorized by the NRA after application has been filed by a local group or organization. Application forms are available from the NRA on request. Sanctioned League scores are used for classification.
- (i) Postal Matches – Organized by the NRA and publicized through the Shooting Sports USA announcements and/or special mailings. A Postal Match or home range match is a competition in which entrants fire separately on their home ranges and exchange scores or submit their scores and/or targets to NRA Headquarters where scores are evaluated and ranked. The firing of Postal Match scores must be witnessed.

- (j) Special Tournaments – May be sanctioned by the NRA for types of shooting not otherwise part of the NRA program.
- (k) State and Senior Games – Tournaments which are part of the State and Senior Games program. Such tournaments are not charged fees, nor will any scores fired be used for classification. A simplified sanctioning procedure may be used, and the events will be listed in Coming Events with the only contact being the State Coordinator.

● 1.7 Types of Matches

- (a) Match – A complete event as indicated in the program for the awarding of certain specific prizes. A match may consist of one or of several stages. It may, in the case of aggregate matches, indicate the scores fired in several subsidiary matches.
- (b) Stage – A portion of a match which consists of one or more strings fired in one position, distance, time allowance (slow or rapid fire, for example), or target.
- (c) Open Match – A match open to anyone, except that if so stated in the program an open match may be limited to one or any combination the following:
 - (1) United States citizens
 - (2) Members of the National Rifle Association of America
- (d) Restricted Match – A match in which the competition is limited to specified groups, i.e. juniors, women, police, civilians, veterans, etc.; or to specified classes, i.e. Masters, Experts, Sharpshooters, Marksman, etc.
- (e) Classified Match – A match in which awards are given to the winners and to the highest competitors in several specified classes such as Masters, Experts, Sharpshooters, and Marksmen. The classification of competitors may be accomplished by the National Classification System (Sec. 19) or by other means. The program for classified matches must specify the groups or classes in which awards will be made.
- (f) Invitational Match – A match in which participants are limited to those who have been invited to compete.
- (g) Squadded Individual Match – A match in which each competitor is assigned a definite relay and target by the Statistical Office. Failure to report on the proper relay or firing point forfeits the right to fire. All entries must be made firing commences in that match, except when otherwise stated in the tournament program.
- (h) Unsquadded individual Match – A match in which the competitor is not assigned a definite relay or target by the Statistical Office. The competitor reports to the Range officer within the time limits specified in the program and is then assigned to a target and relay in which to fire.
- (i) Re-Entry Match – A match in which the competitor is permitted to fire more than one score for record; one or more of the highest scores being considered to determine the relative rank of competitors. The number of scores which may be fired, and the number of high scores to be considered in deciding the relative rank of competitors must be specified in the program. Scores fired in these matches shall not be used for classification purposes.
- (j) Squadded Team Match – A match in which the teams are assigned a definite time to fire. Teams may be assigned one or more adjacent targets. All entries must be made before firing commences in that match. The entire team must report and fire as a unit.
- (k) Unsquadded Team Match – A match in which the teams may report to the firing line at any time within the limits specified in the program, targets being assigned by the Range Officer. The entire team must report and fire as a unit, unless the program provides otherwise.
- (l) Aggregate Match – An aggregate of the scores from two or more matches. This may be an aggregate of

match stages, individual matches, team matches or any combination, provided the tournament program clearly states the matches which will comprise the aggregate. Entries in aggregate matches must be made before the competitor commences firing in any of the matches making up the aggregate match.

PUBLIC AFFAIRS

All tournament sponsors are urged to give special consideration to the needs of news media personnel in order to achieve maximum publicity for the competition. Public news media personnel representing print and/or broadcast should be given every consideration and cooperation in keeping with the proper conduct of the competition.

2. ELIGIBILITY OF COMPETITORS

Eligibility of Competitors - The conditions of a match shall prescribe the eligibility of competitors, team or individuals, in accordance with Rule 1.6 and/or the definitions contained in Section 2. Any limitation of eligibility to compete must be stated in the match program.

INDIVIDUALS

2.1 and 2.1.1 – Moved to Glossary

2.2 Civilian - Any civilian including all members of the Reserve Officers Training Corps (ROTC, NROTC and AFROTC), personnel of the State Security Forces (e.g. State Guard organizations have no federal recognition), retired members of each of the several services comprising the Armed Forces of the United States, and members and former members entitled to receive pay, retirement pay, retainer pay or equivalent pay, are classified as civilians except as noted in the example below. All competitors who are enrolled undergraduates of any of the services academies will be considered as civilians and may compete in collegiate and ROTC categories.

Individuals of any Reserve or National Guard component who, during the present calendar year, have not competed as National Guard (2.5) or Regular Service (2.6) or Reserve component (2.7) and have not been provided Service support for competition (in the form of firearms, ammunition, payment of travel or other expenses), wholly or in part, may fire as civilians. The provision of firearms and ammunition for a specific competition (e.g., National Matches or CPRPFS Regional Leg Matches), when such is available to both military and civilian competitors, is not considered Service support under this Rule.

Unless specifically authorized to do so by the tournament program, members of the regular Army, Navy, Air Force, Marine Corps, Coast Guard; members of the reserve components on active duty; retired personnel of the several services comprising the Armed Forces of the United States on active duty; or police (2.4) are not permitted to compete as civilians.

2.2.1 Senior Competitors - A person may compete as a senior beginning January 1 of the calendar year in which their 60th birthday occurs.

2.3 Junior - A person may compete as a Junior through December 31 of the calendar year in which his or her 20th birthday occurs. Individuals who have National Guard, Reserve, or active duty status and receive support (as defined in Rule 2.2) may not compete as juniors.

2.3.1 Intermediate Junior - A junior may also compete as an Intermediate Junior from January 1 of the calendar year in which his or her 15th birthday occurs through December 31 of the calendar year in which his or her 17th birthday occurs.

2.3.2 Sub-Junior - A Junior may also compete as a Sub-Junior through December 31 of the calendar year in which his or her 14th birthday occurs.

2.4 Police -

- (a) Regular full-time Law Enforcement Officers of a regularly constituted law enforcement agency of a municipal, county, state or federal government. "Full-Time" Police Firearms Instructors in Law Enforcement or Police Academies are eligible to compete in the police category. Official current identification from the agency employing a civilian full-time police firearms instructor will be required.
- (b) Full time salaried Railroad Police; Penal Institution Guards; Industrial Police including Bank Guard; and Armored and Express Company Guards.

- (c) Officers of a regularly organized Reserve or Auxiliary named in (a) above provided that when on duty they are required to perform the same law enforcement functions and/or duties as the Agency to which they are in reserve and are authorized to be armed by the appointing authority.
- (d) Officers who qualify under sections (a) and (b) may after retirement, and if receiving retirement benefits, enter competition covered by these rules. Such retirees who are employed after retirement in any Agency which qualifies for entry in NRA sanctioned competition may not compete as a retired officer, but may compete as a member of the organization in which he is presently serving.
- (e) Military Police: Members of the Armed Forces of the United States, regular or reserve, private detectives, private body guards, honorary police, sheriffs, consultants or any other persons who are members of a body organized for ceremonial purposes may not compete as Police in NRA sanctioned tournaments regardless of the titles given such members.
- (f) Persons employed as Industrial Police by private industry on a part-time basis, or where such employment is not the sole occupation of such person, may not compete in the police category in NRA sanctioned tournaments. Special Officers, Honorary Officers, Civilian Instructors, Deputy Sheriffs, Deputy Game Wardens or Police Officers who are not on a full-time, full pay basis in a single department are not eligible to compete as police.

2.5 National Guard - Federally recognized officers or enlisted persons of the Army National Guard, the Air National Guard, or the Naval Militia of the several states, territories, the District of Columbia or the Commonwealth of Puerto Rico, who are not on extended active duty may be eligible to compete as Junior and/or Collegiate if otherwise qualified.

2.6 Regular Service - Officers or enlisted persons of the Regular United States Army, Navy, Air Force, Marine Corps, Coast Guard, and members of reserve components thereof, who are on extended active duty; provided the term "reserve components" shall include Army National Guard and Air National Guard called into federal service and while in such status may be eligible to compete as Junior and/or Collegiate if otherwise qualified.

2.6.1 Military Veteran - Former military personnel, other than active duty or reserve, in possession of any one of the following documents: Form DD214, retired military identification card such as Veterans Administration card, or membership card in a veterans' organization.

2.7 Reserve Competitor - Officers and enlisted persons of any reserve components of the Armed Forces, exclusive of the Army National Guard and the Air National Guard of the United States, not extended on active duty may be eligible to compete as Junior and/or Collegiate if otherwise qualified.

2.8 Collegiate - Regularly enrolled undergraduate students who carry 12 or more semester hours or the equivalent in an accredited two-or four-year collegiate level institution and who have not received a Bachelor's Degree. Eligibility to compete as a collegiate shall extend for the maximum of four academic years.

2.9 School - Regularly enrolled undergraduate students of any primary or secondary school, who comply with the eligibility rules of their institution.

2.9.1 Military Scholastic - A junior who is an active member of a high school JROTC unit or enrolled in a military high school.

TEAMS

2.10 Team Representation - No individual may be team captain, coach, firing member, or alternate firing member on more than one team in any match.

Note: Entries will not be accepted form "pickup" teams (teams whose members are selected without regard to club or other organizational affiliation) unless the program specifically provides for such eligibility.

● **2.11 Club Teams** - All team members, including team captain and coach, must have been active fully-paid members of the club which the team represents for a period of at least 30 days immediately prior to the competition. The club may be affiliated with the NRA. As specifically allowed by conditions of the program, a person who is not a club member may serve as a non-firing coach of such a team. There are two types of teams

allowed in this Rule:

- (a) Local Club Teams - Local Club Teams must be composed of members who reside within the same state, territory or province or residents of other states who live within 50 miles of the local club.
- (b) Open club Teams – Open Club Teams must be composed of club members all of whom are not necessarily legal residents in the same state, territory or province. More than one team from each club is acceptable.

NOTE: The Internet website “Mapquest” will be used to determine the distance between the local club’s NRA address of record and the competitor’s NRA address of record.

● **2.11.1 Affiliated Other Organizations** – (Article 3, Section 4(b) NRA Bylaws) – All members including team captain and coach of such teams must have been fully-paid members of the organization the team represents for a period of at least 30 days immediately prior to the competition.

● **2.12 State Association Teams** - Members including team captains and coach of State Association Teams must be residents of the state represented. Members of such teams must be individual members of the State Rifle and/or Pistol Association represented, if such State Association provides for individual membership, or be members of a rifle and/or pistol club which is affiliated and in good standing with the State Association concerned at the time of the competition. State Association teams permitted to enter the competitions by the tournament program conditions must be authorized and accredited by the Association for that tournament. Authorization shall be signed by the Associated President, Vice President or Secretary. Such State Association must be affiliated and in good standing with the NRA at the time of competition. If specifically allowed by conditions of the program, a person who is not a State Association member may serve as the coach of a State Association Team, but may not be a firing member.

Note: Teams representing State Associations, Leagues and other associations (composed of more than one club) are not club teams. Such teams may enter NRA sanctioned matches only when the program specifically authorizes such entry.

2.13 Regular Service, National Guard or Armed Forces Reserve Teams - Members of such teams must have been commissioned or enlisted members of their respective service for a continuous period of at least 30 days immediately preceding the day of the competition. Army National Guard, Air National Guard and the Naval Militia personnel may be combined into a single team.

2.13.1 Military Veteran Team - Firing and alternate members of such teams must comply with Rule 2.6.1.

2.14 Police Teams - Firing members of such teams must have been regular full-time members of their respective organizations and in active service for a continuous period of at least 30 days immediately preceding the day of competition. (Rule 2.4.)

2.15 Civilian Club Teams - Firing and alternate members of such teams must comply with Rules 2.2 and 2.11.

2.16 College Teams - Firing and alternate members of such teams must comply with Rules 2.8 and 2.11.

2.17 School Teams - Firing and alternate members of such teams must comply with Rules 2.9 and 2.11.

2.17.1 Military Scholastic Team - Firing and alternate members of such teams must comply with Rules 2.1 and 2.9.1.

2.18 Junior Club Teams - Firing and alternate members of such teams must comply with Rules 2.3 and 2.11.

2.20 Residence - In those matches which are limited to residents of any specified geographical area a “resident” is defined as:

- (a) A person who presents a photo identification issued by a government entity, which shows a residential address within the specified geographical area.
- (b) Military Personnel: The place of residence of members of the Military on active duty is defined as the place

at which they are stationed by reason of official orders, provided they have been so stationed within the specified area for a period of at least 30 days immediately prior to the day of the match. In the case of retired, Reserve, or National Guard personnel not on active duty, the provisions of paragraph (a) will apply. Naval personnel assigned on sea duty qualify for a residence in the area which is the usual base or home port of the unit to which attached.

(c) Federal and State Law Enforcement Officers: The provisions of paragraph (b) will apply.

3. EQUIPMENT AND AMMUNITION

This section defines authorized equipment. Where alternative types of equipment are shown, the least restrictive conditions apply unless the tournament program sets forth limitations.

The intent of the Precision Air Rifle Rules are to provide a low cost entry level program and are designed specifically to encourage broad participation in this shooting sport. These are intended to insure equal fairness for all shooters. Anything that may give one competitor an advantage over others, and which is not specifically authorized in these rules, or which is contrary to the intent and spirit of these rules is prohibited. See Rule 3.18.

3.1 Precision Air Rifle - Any type of compressed air or CO2 rifle of conventional appearance which conforms to the specifications shown in Figure 1 and with the following additional restrictions:

- (a) Caliber: 4.5 mm (.177 caliber).
- (b) A set trigger is prohibited.
- (c) Thumbhole, thumb rest, palm rest, heel rest, hooked butt plate (figure 6) and spirit level are prohibited (See Rule 3.14.2). Material may be added to the stock as long as it does not exceed maximum dimensions. Any additions must conform to the existing form and may not be anatomically shaped.
- (d) Sights: See Rule 3.7 and Figure 1.
- (e) The weight of the rifle with sights (including handstop) may not exceed 5.5 kgs (12.12 lbs.).
- (f) The butt plate and cheek piece may be adjusted between positions as long as the rifle continues to comply with the specifications given in Figure 1.
- (g) Barrel weights are permitted provided the overall weight of the rifle does not exceed the maximum limitations and are within a radius of 1.18 inches (30 mm) from the center of the barrel. Any other weights must be within the dimensions of the stock.
- (h) Material that gives increased grip may not be added to the fore-end, pistol grip, butt plate, or lower part of the stock. Adhesive sprays may not be used on the rifle or clothing.
- (i) The total length of the air rifle system measured from the back-end of the mechanism or air cylinder to the foremost end of the system, including any extension, (whether it is attached to the barrel or not) may not exceed 850 mm (33.46 inches). The extension tube must not be perforated. Any construction or devices inside the barrel or tubes other than rifling and chambering for pellets are prohibited. The use of compensators or muzzle brakes is prohibited.
- (j) A biped or attached rifle rest is not permitted while shooting.
- (k) A handstop/sling swivel may not be attached to the rifle in the standing position.

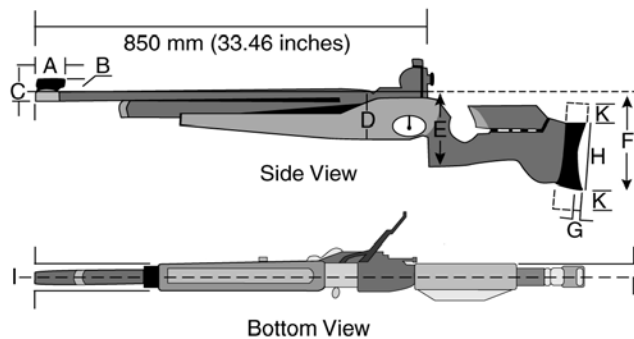

FIGURE 1

INTERNATIONAL SHOOTING SPORT FEDERATION SPECIFICATIONS
AIR RIFLES MAXIMUM MEASUREMENTS
FOR DIMENSIONS C, D, E, F, AND J FROM CENTERLINE OF BARREL

- A. Length of front sight tunnel: 50 mm (1.97 inches)
- B. Diameter of front sight tunnel: 25 mm (.98 inch)
- C. Height of center of front sight ring or top of post - Radius (except for those shooters firing from the right shoulder but aiming with their left eye) (Reverse for left handed shooters): 60 mm (2.362 inches)
- D. Depth of fore-end in front of trigger guard: 90 mm (3.54 inches)
- E. Lowest point of pistol grip: 160 mm (6.29 inches)
- F. Lowest point of stock or toe butt plate: 220 mm (8.66 inches) with the butt plate in its maximum downward position.
- G. Depth of curve of butt plate: 20 mm (.79 inch)
- H. Heel to toe length of butt plate: 153 mm (6.02 inches)
- I. Total thickness (breadth) of fore-end: 60 mm (2.36 inches)
- J. Maximum distance (horizontal) of cheek piece from centerline of barrel: (40 mm (1.58 inches)
- K. Offset of butt plate parallel to the center-line of the normal end of the butt plate left or right 15 mm (.59 inches). Movement of butt plate, upward or downward from the neutral position: 30 mm (1.18 inch). The complete butt plate (not part) may be turned on the vertical axis. Turning the butt plate on the horizontal axis is not permitted.

Note: Front sight may not extend beyond the apparent muzzle of the rifle.

3.7 Sights

- (a) Any sight not containing lens or system of lenses is permitted. Light filters may be fitted to the front or rear sight.
- (b) Correcting glasses may be worn by the shooter, but may not be attached to the air gun, in the rear sight, front sight, etc.
- (c) Telescopic sights on rifles are prohibited.
- (d) Only cant indicating devices inside the front sight are permitted. Spirit levels ("bubble levels") are not permitted.
- (e) A prism or mirror device may be used when shooting from the right shoulder while aiming with the left eye or vice versa, provided it does not have a magnifying lens or lenses. It must not be used when shooting from the right shoulder when aiming with the right eye or vice versa.
- (f) Prohibited - Any sighting device programmed to activate the firing mechanism is prohibited.
- (g) A blinder may be attached to the rifle or rear sight. The blinder must not be more than 3.3 mm (1 1/4 inches) deep nor extend more than 100 mm (~4 inches) from the center of the rear sight aperture on the side of the aiming eye. Side Blinders attached to the hat, cap, shooting glasses, or to a headband, not exceeding 40 mm (1 1/2 inches) deep are permitted (See A). These blinders must not extend further forward than to a line from the center of the forehead. A piece to cover the non-aiming eye not larger than

30 mm (1/14 inches) wide is permitted (See B).

● **3.7.1 Sights -**

- (e) A blinder may be attached to the rifle or rear sight. The blinder must not be more than 3.3 mm (1 1/4 inches) deep nor extend more than 100 mm (~4 inches) from the center of the rear sight aperture on the side of the aiming eye. Slide Blinders attached to the hat, cap, shooting glasses, or to a headband, not exceeding 40 mm (1 1/2 inches) deep are permitted (See A). These blinders must not extend further forward than a line from the center of the forehead. A piece to cover the non-aiming eye not larger than 30 mm (1/14 inches) wide is permitted (See B).

3.8 Spotting Scopes -The use of a spotting scope, with necessary tripod to visually locate shot holes on a target is permitted. It may be positioned forward of the shooter's forward shoulder. (Rule 9.9)

3.9 Shooting Kits - The shooting kit may not be placed forward of the firing line, except that in the standing position a shooting kit, table, or stand may be used as a rifle rest between shots. The shooting kit, table or stand may not be of such size or construction as to interfere with shooters on adjacent points or to constitute a wind break. When using a rifle rest, competitors must take special care to be sure the muzzle of the rifle, when resting on the stand, is not pointed towards or near another competitor.

● **3.10 Ground Cloths** – Ground cloths or mats with a maximum dimensions of 1.25 x 2 meters (49.2 x 78.7 inches) in size and a maximum total thickness of 5 cm (approximately 2 inches) may be used provided it is not constructed or used in a manner to provide artificial rest or support. Ground cloths shall not be used standing.

3.11 Clothing Regulations - General-All clothing must be made of flexible material that does not materially change its physical characteristics under commonly accepted shooting conditions. All lining, padding, and reinforcements must meet the same specifications. Lining and padding must not be quilted, cross-stitched, glued, or otherwise affixed to the outer layer other than at normal tailoring points. All lining or padding must be measured as a part of the clothing. The use of any special devices, means or garments which support or immobilize the shooter's legs, body or arms more than everyday clothing is prohibited. Any zippers prohibited by the following rules are permitted if made secure (unable to be further opened or closed).

- (a) The Thickness Measuring Device - The device used to measure the thickness of clothing and shoes shall be capable of measuring one-tenth of a millimeter. Measurements will be taken with a 5kilogram (11.02 lbs.) weight applied. The device must have two round, flat surfaces, each 3 cm in diameter facing each other.

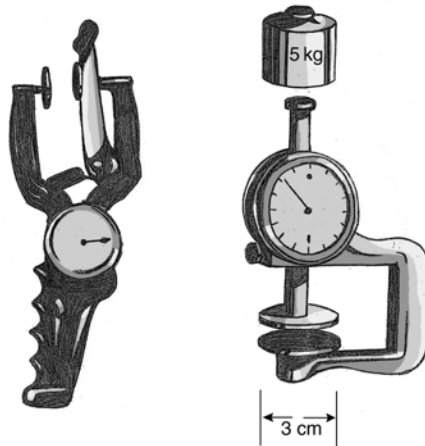

FIGURE 2

SAMPLE MEASURING DEVICES FOR MEASURING
ALL ARTICLES OF CLOTHING

● **3.11.1 Clothing Specifications -**

(a) The Shooting Jacket: Materials must be according to the requirements of Rule 3.11 “General”.

- (1) The body and sleeve of the jacket, including the lining, must not exceed 2.5 mm (.098 inch) in single thickness and 5 mm (.197 inch) in double thickness at any point where flat surfaces may be measured. The maximum thickness of any reinforced or padded area, including the jacket material and all lining, is 10 mm (0.394 inches) single thickness, or 20 mm (0.787 inches) double thickness.
- (2) The jacket must not be longer than the bottom of the balled fist shown in Figure 3A.
- (3) Closure of the jacket may be only a non-adjustable means. No zipper or other closing device is permitted other than those specified in the rules and figures. All straps, laces, binding or devices, which may be construed as artificial support are prohibited. It is permitted to have one zipper or not more than two straps to take up loose material in the area of the shoulder pad. (Figure 3A)
- (4) The jacket may not overlap more than 100 mm (3.94 inches) from the edge of the jacket to the closure. (See Figure 3A.) The jacket must hang loosely on the body of the wearer, and to determine this, the jacket must be capable of being overlapped beyond normal closure by at least 70 mm (2.75 inches). The 70 mm (2.75 inches) are measured from the center of the button to the outside edge of the button hole. (Figure 3B)
- (5) An interchangeable or removable back panel to give ventilation is permitted. The fastenings of this panel must be such that they do not give additional support to the shooter. Each removable back panel must be approved by the equipment control. All panels must be the same width and length. The construction of the back panel may include more than one piece of material, including a band or strip on which the shooter's name may be affixed, provided that this construction does not materially stiffen or reduce the flexibility of the jacket. All parts of the back panel must comply with the thickness limit of 2.5mm when measured over a flat surface.

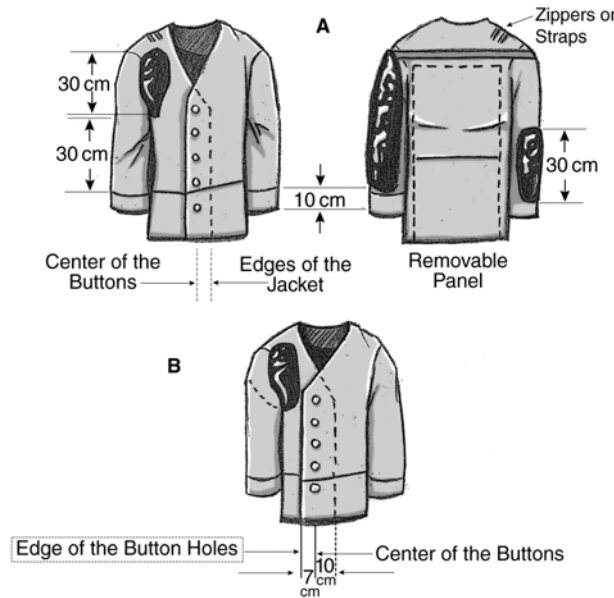

FIGURE 3

Figure 3A - Shooting Jacket

- (6) In all shooting positions, the sleeve of the coat may touch the stock, but cannot rest between the hand or glove and the stock of the rifle creating extra padding between the rifle and the glove or hand.
- (7) Reinforcements may be added to both elbows to one half (½) the circumference of the sleeve. On the

arm that holds the sling, the reinforcement may extend from the armpit to a point 10 cm (3.9 inches) from the end of the sleeve. The reinforcement on the opposite arm may have a maximum length of 30 cm (11.8 inches).

- (8) Only one hook, loop, button, or similar device may be fastened to the outside of the sleeve or shoulder seam on the sling arm to prevent the sling from sliding.
- (9) Reinforcement on the shoulder where the butt plate rests must not be larger than 30 cm (11.8 inches) in the longest dimension.
- (10) All inside pockets are prohibited. Only one external pocket is permitted, located on the right front side (left side for left-handed shooters) of the jacket. This is to say that all other pockets in jackets and all pockets in trousers are prohibited.
- (11) No velcro, sticky substances, liquid or spray may be applied to the outside of the jacket, pads or equipment to prevent slipping. Roughening material of the jacket is permitted.
- (12) Only one shooting jacket may be approved by the equipment control for each competitor for all rifle events in any match or tournament.

(b) The trousers:

- (1) Materials must be according to the requirements of Rule 3.11 "General." The shooting trousers, including the lining must not exceed 2.5 mm (0.098 inch) in single thickness; or 5 mm (.197 inch) in double thickness at any point where flat surfaces may be measured. The maximum thickness of any reinforcement or padded area, including the trouser material and all linings, is 10 mm (0.394 inches) single thickness or 20mm (0.787 inches double thickness).
- (2) Trousers must not fit or be worn higher on the body than 50 mm (1.96 inches) above the crest of the hip bone. The trousers must fit loosely around the legs. Drawstrings, zippers, or fasteners to tighten the trousers around the legs or hips are prohibited. The shooter must be able sit in a chair with the trousers on and with fasteners or closures in the closed position.
- (3) If the trousers have a waistband, it may not be more than 70 mm (2.75 inches) wide and may be closed by one hook and up to 5 eyes, up to 5 points adjustable snap fasteners, buttons or Velcro. Only one type of closure is permitted. A Velcro closure combined with any other closure is prohibited.
- (4) A normal waist belt not more than 40 mm (1.57 inches) wide and 3 mm (0.011 inches) thick or elastic suspenders may be worn to support the trousers. If a belt is worn in the standing position, the buckle or fastening device must not be used to support the left arm or elbow.
- (5) Only one pair of shooting trousers may be approved by the equipment control for each competitor for all rifle events in any match or tournament. This does not prevent the shooter from using ordinary trousers. If special shooting trousers are not worn, ordinary trousers may be worn, providing they do not provide artificial support.
- (6) Zippers, buttons, velcro, or similar types of fasteners, may be used in the trousers only in the following places: one type of fastener in the front to open and close the trousers fly. The fly must not be lower than the level of the crotch. Any holes that cannot be closed are permitted. Only one other fastener is permitted in each trousers leg. The opening (fastener) must not start closer than 70 mm (2.75 inches) from the top edge of the trousers. It may, however, extend to the bottom of the trouser leg. One fastener is permitted either in the front of the upper leg or the back of the leg, but not in both places in one leg.

Figure 3C - Shooting Trousers

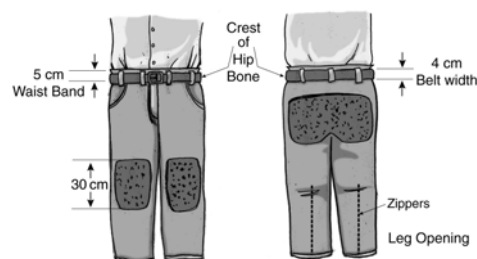

FIGURE 3C

- (7) Reinforcement or padding may be added to the seat and both knees of the trousers. The seat pad must not exceed the width of the hips and may not be longer than to cover the normal wear points on the seat of the wearer. The kneepads must not be wider than half the circumference of the leg and can have a maximum length of 300 mm (11.8 inches).
- (e) Shoes – Normal street type of light athletic shoes are permitted so long as they do not exceed the top of the ankle. Shooting boots/shoe are not permitted.
- (1) The shoes which are worn must be a matched pair.
 - (2) The sole must be flexible at the ball of the foot. Orthopedic inserts are allowed.
 - (3) The upper part (above the line of the sole) material must be soft, flexible, pliable, not thicker than 4 mm (0.16 inch) including all lining, when measured on any flat surfaces such as point D in Figure 4.
 - (4) The height of the shoe from the floor to the highest point (Dimension C, Figure 4) may not exceed two thirds ($\frac{2}{3}$) of the length (Dimension B+10 mm); for example, if shoe length (B+10 cm) is 30 cm (11.8 inches), the height (C) may not be more than 20 cm (7.9 inches).
 - (5) Only one pair of special shooting boots may be approved by the equipment control for each competitor for all rifle events in any match or tournament. This does not prevent the shooter from using normal street or athletic type training shoes in prone as long as all shoes worn comply with the requirements of Figure 4

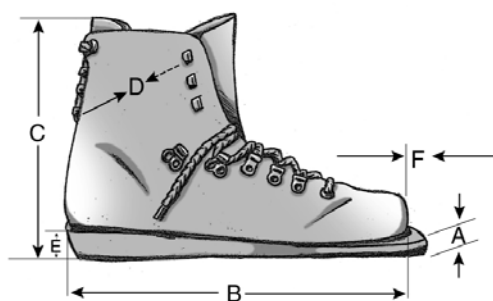

FIGURE 4

- A. Maximum thickness of sole at the toe: 10 mm (.39 inch).
- B. Overall length of shoe according to size of wearer's foot.
- C. Maximum height of shoe not to exceed two thirds ($\frac{2}{3}$) length of B + 10 mm.
- D. Upper part of shoe material maximum thickness 4 mm (.16 inch).
- E. Heel maximum 30 mm (1.18 inches).
- F. The extension of the soles must not be more than 10 mm and may be cut at an angle either to one or both soles.

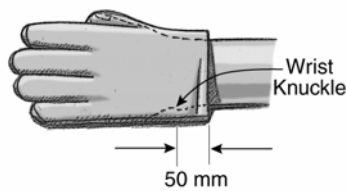

FIGURE 5

Figure 5 - Shooting Glove

- (d) Shooting Gloves: Material as specified in Rule 3.11. Any shooting glove meeting the following specifications/restrictions is permitted.
- (1) Total thickness may not exceed 12 mm (.47 inch) measuring front and back materials together at any point other than on seams and joints.
 - (2) The glove may not extend more than 50 mm (1.9 inches) past the wrist measured from the center of the wrist knuckle.
 - (3) Any strap or closure device at the wrist is prohibited. However, a portion of the wrist band may be elasticized to enable the glove to be put on, but it must leave the glove loose around the wrist.
- (e) Other Clothing:
- (1) All clothing worn under the shooting jacket and under the shooting trousers may not be thicker than 2.5 mm (.098 inch) single or 5 mm (.197 inch) double thickness. Only normal personal undergarments or training clothing may be worn under the shooting jacket or trousers. Training clothing worn under the shooting trousers includes such garments as a track suit, but not ordinary trousers, jeans, etc.
 - (2) Any other undergarments are prohibited.
 - (3) A shooter may wear a cap, hat, or headband as long as it does not interfere with range officials or other shooters.
 - (4) Name tags and/or Competitor numbers may be displayed on the back of the shooter's jacket, starting near the shoulder blade line. These additions will not interfere with the sling or provide support in any way. The competitor number must be for the current tournament or match.

3.13 Slings -A shooting sling with a maximum width of 40 mm (1.57 inches) is allowed in the prone and kneeling positions. It may be worn only over the upper part of the left arm (right arm for left-handed shooters) and from there be connected to the fore-end of the rifle stock. Sling may pass along one side of the hand or wrist only. No part of the rifle may touch the sling or any of its attachments except at the sling swivel and handstop. The sling is not allowed in the standing position.

3.14.1 Kneeling Roll - One cylindrical roll for shooting in the kneeling position is allowed. It may be a maximum of 25 cm (9.84 inches) long and 18 cm (7.08 inches) in diameter, and made of soft and flexible material. Binding or using other devices that change the shape of the roll from a cylinder is not permitted. The use of the kneeling roll is optional and not required.

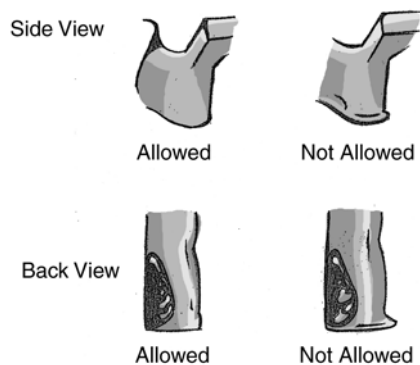

FIGURE 6: HEEL REST

3.14.2 Heel Rest or Thumb Rest - A heel rest is any protrusion, extension or depression on the front or side of the pistol grip designed to prevent the hand from slipping. Such a protrusion or depression is prohibited. See

3.17 Pellets - Only .177 Cal. (4.5 mm) lead pellets are permitted.

3.18 General - All devices or equipment which may facilitate shooting and which are not mentioned in these Rules, or which are contrary to the spirit of these Rules are prohibited. The Official Referee or Match Director has the right to examine a shooter's equipment and apparel. It is the Shooter's responsibility to submit questionable equipment and apparel for official inspection and approval prior to the beginning of the match. Only Air Rifles which have been approved for the competition concerned may be used. (See Rule 3.1.)

3.19 Eye Protection -All competitors and other personnel in the immediate vicinity of the range complex are urged to wear eye protection devices.

3.20 Ear Protection -All competitors and other personnel in the immediate vicinity of the range complex are permitted to wear hearing protection devices, and are urged to do so as circumstances require. Only sound reducing devices may be worn by competitors forward of the ready line during firing. Radios, tape recorders, or any type of sound producing or communication systems are prohibited forward of the ready line during firing. Competitors should be aware that match sponsors (and/or range) may require that all competitors wear eye and ear protection while attending a match on their range.

● **3.21 – CBI's are required.**

4. TARGETS

● **4.1 Official Targets** – In Registered and Approved rifle matches only targets bearing the words “Official National Rifle Association” and the eagle and shield insignia of the Association or ISSF approved targets will be used without any alterations. Targets used in National Championships will be NRA Official targets or ISSF approved targets. When appropriate, targets will be mounted only vertically on existing range hangers (frames) with the highest numbered bullseye(s) at the bottom. All NRA Official Competition Targets are printed by NRA licensed manufactures only. They may not be modified by the user or the manufacturer, except with specific written permission from NRA Competitive Shooting Division. NRA target masters are made using Computer Assisted Design and must be used in production of all NRA targets. The use of electronic scoring targets is authorized in all events as long as the fact is included in the match program

NOTE: The use of other targets may be scheduled for other rifle matches by sponsors provided the conditions are clearly stated in the match program.

4.2 10 Meter Targets

(a) Official NRA Targets AR-5/1 (single bullseye), AR-5/5 (5 bullseye), AR-5/10 (12 bullseye). International air rifle targets for firing a 10 meters. The scoring rings 4 through 9 are black.

10 ring	0.5mm
9 ring	5.5mm
8 ring	10.5mm
7 ring	15.5mm
6 ring	20.5mm
5 ring	25.5mm
4 ring	30.5mm
3 ring	35.5mm
2 ring	40.5mm
1 ring	45.5mm
Ring thickness	0.1mm to 0.2mm

Permitted deviation from the specified dimension-maximum 0.05 mm. Minimum visible size of target card (single bull targets) - 8 x 8 cm.

(b) The TQ-18 Target is encouraged for use during introductory training and initial skill development.

4.3 Target Paper - The target paper must be of non-reflecting color and material so that the black bullseye (center) is clearly visible under all normal light conditions at the appropriate distance. The target card and printing must retain dimension accuracy without distortion under all weather and climate conditions. The card material must register all shot holes without excessive tearing when the pellet passes through.

5. POSITIONS

Positions - The positions for use in a match shall be stated in the program under conditions of the match and shall be in accord with the definitions of positions prescribed in this section.

5.1 The Ground - All reference to "the ground" in the following position rules are to be considered as the surface of the firing point, floor, or shooting mats. No portion of the shooter's body may contact the ground forward of the firing line (Rule 6.1), although those portions of the shooter's body or rifle which do not contact the ground may extend forward of the firing line.

5.2 Artificial Support - Any supporting surface except the ground not specifically authorized or use in the Rules of the position prescribed. Digging or use of elbow heel holes at the firing points or the use of depressions which form artificial support is prohibited except as individually authorized for a physically handicapped shooter.

5.3 Position of Rifle Butt - In all positions, the butt of the rifle must be held against the front of the shoulder on the outside of the shirt or shooting coat and must not touch the ground.

5.6 Prone - The shooter may lie on the bare surface of the firing point or he may use a mat. The body is extended on the firing point with the head toward the target. The rifle will be supported by both hands and one shoulder only. The cheek may be placed against the rifle stock while aiming. The rifle may be supported by means of a sling. The fore-end behind the left hand or any part of the rifle must not rest on the sling or its attachments. The rifle may not touch or rest against any other point or object. Both forearms, as well as the sleeves of the shooter's jacket, must be clearly and visibly raised from the surface of the firing point. The shooter's forward forearm may not form an angle less than 30 degrees from the horizontal (floor or mat), on which the elbow rest (measured through the axis of the forearm). (Left-handed shooters reverse these descriptions.)



(See Illustrations indicating some approved positions)

● **5.10 Kneeling** - The competitor shall touch the ground with the right foot, the right knee and the left foot. The rifle shall be held in the same way as when shooting in the prone position, i.e. with both hands and the right shoulder. The left elbow shall be supported on the left knee. The point of the elbow must not be more than 10 cm (approximately 4 inches) over or 15 cm (approximately 6 inches) behind the point of the knee. The rifle may be held by means of the sling. The fore-end behind the left hand or any part of the rifle must not rest on the sling or its attachments. If the kneeling roll is placed under the instep of the right foot, the foot may not be turned at an angle of more than 45 degrees. If the kneeling roll is not used, the foot may be positioned at any angle, to include placing the side of the foot and the lower leg in contact with the ground. No portion of the upper leg or buttocks may touch the ground at any point. The shooter may kneel completely on the ground cloth and/or thick mat (Rule 3. 10 and 3. 10. 1) or he may have only one or two of the three points of contact (toe, knee, foot) on the ground cloth and/or thick mat. Only the trousers and underclothing may be worn between the shooter's seat and his heel. Articles may not be placed between these points or under the right knee. (Left-handed shooters reverse these descriptions.)



See Rule 3.14.1.



● **5.12 Standing** - The competitor shall stand free with both feet on the ground without any other support. The rifle shall be held with both hands and the shoulder, the cheek and the part of the chest next to the right shoulder. However, the chest beyond the area of the right shoulder and right chest must not support the rifle. The left upper arm and elbow may be supported on the chest or on the hip. Use of the sling attached to the body and/or rifle is prohibited. During shooting, the sling swivel may not contact the supporting hand. (Left-handed shooters reverse this description.)

6. RANGE STANDARDS

6.1 Firing Line - The firing line is immediately in front of the firing point, and must be marked so that it can be clearly seen by coaches and shooters. The shooting distance is measured from the firing line edge closest to the shooter to the face of the targets.

6.2 Firing Points -The part of the range provided for the shooter immediately to the rear of the firing line. Each firing point should be a minimum width of 48 inches. Each firing point is numbered to correspond to the target numbers downrange.

A width of 40 inches is acceptable if range conditions will only allow this width. However, 48 inches is ideal for position shooting and should be used whenever possible for shooters' comfort.

6.2.1 Shooting Ranges, Specific -

- (a) 10 Meters -The shooting range shall normally be equipped with target carriers. Simpler ranges may also be built with fixed targets, provided safety is observed in every respect. The ranges may be constructed either in the open air or indoors.
- (b) The recommended height of the target for the standing position is 1.40 meters (55.12 inches) +/- 0.05 meters (1.96 inches) above the level of the firing point. Target heights for all positions may be adjustable within the range of the target holders. Lateral deviations of left or right of the center of the target should not exceed 25 cm (9.8 inches).
- (c) Newly constructed shooting ranges should ensure that the shooting stations have a minimum roof height of 2.2 meters (86.6 inches) above the level of the firing point floor.

● **6.3 Shelter** - The firing point on outdoor ranges should be covered and enclosed on three sides, open toward the targets. There must be ample room for Range Officers and witnesses to move freely at the rear of the shooters.

6.4 Shooting Distance -The shooting distances shall be measured from the target to the edge of the firing line closest to the shooter. The distance will be 10 meters \pm .05 meters.

● **6.5 Illumination** - Artificial illumination of outdoor and indoor ranges is permitted. An illumination level of 1500 lux throughout the range is recommended. The firing should also be well illuminated.

6.6 Target Numbers - Target positions or frames downrange will be numbered on alternating backgrounds of contrasting colors. The number will be large enough to be identified under ordinary conditions with normal vision. Numbers must correspond with firing point numbers.

6.7 Backing Targets - Blank targets may be hung 3 inches behind record targets to determine crossfires.

6.8 Target Equipment - The targets (within a group or range) shall be placed at the same height, each target corresponding to one firing point. The target system must ensure the necessary degree of safety, accurate control of timing, and the efficient scoring and changing of the targets. The targets shall be fixed in a manner that their visible movement is not distracting to the competitors, even in high winds. See Rule 6.2.1.

6.9 Wind Flags - A wind flag is a strip of cloth affixed to the top of a stake which is approximately at target height. Personal wind flags, gauges or instruments are prohibited. Wind flags will be placed as close to the path of the pellet's flight as practical without interfering with the pellet's flight or the shooter's view of the target while he aims.

NOTE: 10 Meter outdoor ranges should have wind flags erected between the firing lanes of at least every fourth position at approximately 5 meters (195 inches). The flags will be 5 cm (1.97 inches) x 40 cm (15.7 inches) and made of a cotton material weighing approximately 150 g (5.3 oz) per square meter.

6.11 Range Clock - The range should be equipped with a large clock which can be clearly seen by the competitors and the Range Officers. If such clock is not available, the Range Officers and/or Jury must bring the time remaining to the attention of the shooters according to Rule 8.4.

7. COURSES OF FIRE

The following courses of fire are most commonly found in NRA Sanctioned Precision Air Rifle Position Competition, fired on standard NRA targets described in Section 4. See Section 8 for Time Allowances, Section 17 for Courses of Fire for which National Records are recognized and Rule 19.4 for Courses of Fire used for Classification. Other courses of fire, other time limits, or the use of other targets may be scheduled by sponsors provided the conditions are clearly stated in the program.

NOTE: The match program must clearly state the course or courses of fire.

7.1 10 Meter Precision Air Rifle (Rule 3.1)

(a) Shooting Program -

1. 10 Shots in each position: prone, standing, and kneeling in that order.
2. 20 Shots in each position; prone, standing, and kneeling in that order.
3. 40 shots in each position; prone, standing, and kneeling in that order.

(b) Target-Air rifle target for 10 meters - (Rule 4.2(a))

(c) Time Limits-Shooting time including sighting shots is 1 ½ minutes per record shot prone and kneeling, and 2 minutes per record shot standing.

(d) Dry Firing - Allowed only during preparation period. After record firing begins dry firing is not allowed. "Dry Firing" means the release of the cocked trigger mechanism of an unloaded rifle or the release of the trigger mechanism of a gun fitted with a device which enables the trigger to be operated without discharging the gun.

● **7.10 Finals Procedure** – The shooter must use a rifle that was used in one of the qualifying courses.

(a) Finalist in each event: 8 competitors

(b) Reporting to the range for Finals: Competitors must report to the appropriate Range Official 20 minutes before the scheduled beginning of the Finals event.

(c) Preparation time and Presentation of Finalists: The three (3) minutes preparation time starts with the command, **PREPARATION BEGINS NOW**. The competitors will be introduced to the spectators during the preparation time and if necessary the first minutes of the sighting time. Before and during preparation period shooters may handle their rifle, dry fire and carry out holding and aiming exercises on their assigned firing points.

(d) Sighting Time: At the end of the preparation time the Range Officer will announce **SIGHTING TIME START**. Seven (7) minutes will be allowed for unlimited sighting shots. Thirty (30) seconds before the end of the sighting time the range officer will announce **30 SECONDS**. At the end of the 7 minutes the Range Officer will announce **STOP**.

(e) Start Time: The starting time for each final event should be printed in the official program or announced by Match Director's Bulletin. The starting time begins with the command **LOAD** for the first competition shot

(f) Any finalist who is not in his/her assigned position at the beginning of the start time is automatically given the last place in the final results and is not allowed to participate in the finals.

(g) Start Positions: The competitors who qualified for the finals will have the following start positions according to their qualifications rank:

Note: All competitors will be given new start numbers corresponding to their placing. Last names should also be placed on the new start number.

Firing Point: 1 2 3 4 5 6 7 8
Start Point: 1 2 3 4 5 6 7 8

(h) Number of Sighting Targets and Shots per Target:

1. Number of sighting targets: (Paper Targets) 4 targets
2. Number of competition shots per target: (Paper Targets) One (1) shot per target

(i) Final Results: In all events the results of the finals competition will be added to the individual results of the qualification round

Results of the finals will be printed in the results bulletin.

In all events the final scoring of the series of shots will be made immediately in the target pit or at the firing line of the final competition. Any challenge will be decided immediately and the decision is final.

The scoring of the finals will be conducted, if technically possible, with target reading machines which classify each ring in ten sections (such as 8.1, 8.2, etc., up to the maximum of 10.9). Shots which cannot be classified by target reading machines will be scored by hand, by jury members with ISSF/NRA approved instruments.

Final scores will be used for classifications.

(j) Finals Events:

Air Rifle – Men
Air Rifle – Women

Seven (7) minutes unlimited sighting shots. (Range Officer Gives warning signal 30 seconds before end of sighting time)

One thirty (30) second pause. Range Officer will instruct shooters:

ADVANCE TO COMPETITION TARGET

The final consist of 10 shots and will be conducted single shot-for-shot with the following commands for each shot:

FOR THE FIRST/NEXT COMPETITION SHOT LOAD

After this command the competitors load their rifles. The rifle must not be loaded before this command is given. That means the air rifle must be cocked only after the command **LOAD**. The pellet must be loaded into the chamber only after the command **LOAD**.

ATTENTION 3-2-1 START

The shooter has 75 seconds for standing for one shot. This command with the count-down should give the competitor sufficient time to take their shooting position. The shooting time starts with command **START**. Each shot fired before the command **START** will be counted as a miss (zero).

STOP

This command is given after the last competitor has fired or immediately after termination of the shooting time whichever comes first. The last second (75th) has to correspond with the word **STOP**. At this time the fired target will be advanced/returned and the next competition target will be advanced.

4. If a shooter fires more than one shot during the singles shot period, all of those shots must be scored as a zero (0) and counted as part of the ten shot final.
5. After scoring the shot, the procedure indicated in (3) will be repeated until all competitors have fired their 10 shots.

(k) If automatic target carriers are used, the target must be carried in only after the command **STOP** is given to avoid any disturbances of the other finalists.

(l) Aiming exercises are allowed between the commands STOP and the following command LOAD. Dry firing in any form is prohibited.

(n) Decisions in the event of tied scores:

The scores of the qualification round and of the finals series are added. In case of tied scores for the three places at the end of the finals the following rule will apply:

In case of tied scores after the finals in series the shooters who are tied will continue to shoot single shot-for-shot until the tie is broken.

Shooters who are tied remain at their firing points. All other shooters place their firearms in a safe position and leave the firing line immediately after the scoring of their final results has been made. The Final will be continued as fast as possible and without additional sighting shots according to the procedure in (j) (3).

● **7.10.1 -**

(a) A range officer will be appointed to supervise the firing line, issue warnings, deductions and disqualifications in accordance with finals procedures. The range officer will also identify rounds fired prior to the command START and after STOP.

(b) Upon issuing a warning, deduction, or disqualification, the range officer will notify the competitor involved, the chief range officer and the classification officer.

(c) Violations of the Finals Procedure 7.10 (j) (3) and 7.10 (k) will be penalized according to the following format:

1st Offense: WARNING
2nd Offense: DEDUCTION of two points from the next shot.
3rd Offense: DISQUALIFICATION and the shooter will be ranked in the last place of the participating finalists.

(d) Competitors disagreeing with an announced shot value desiring to challenge must declare intent prior to the initiations of the next shot. The challenges shot will be rescored by the classification officer. The official score will be announced before starting the next shot sequence. There is no challenge fee.

(e) Should the Chief Range Officer prematurely announce STOP the following procedure is followed: Announce AS YOU WERE! THE SHOT SEQUENCE WILL BE REPEATED FOR FINALISTS HAVING SHOTS REMAINING TO BE FIRED! The finals sequence 7.10 (j) (3) is initiated.

(f) If the case of an allowable malfunction the competitor is allowed to complete or repeat the fired shot(s) twice during the finals including shoot-offs if the competitor can repair or replace the rifle or pellets within three minutes after the malfunction(s) has been declared allowable.

The procedures are as follows:

The Final will be interrupted in every case.

Events with card targets - Targets will not be collected or scored until the shooter has fired the missing shot.

Events with electronic targets - The Range Officer will not announce the shot evaluation and ranking until the competitor has fired the missing shot.

In all cases of repeated shooting, the starting command of the competition must be given as from the command LOAD.

If a competitor is unable to repair or replace the rifle within 3 minutes, the competitor will lose the shot and the Final will be conducted 3 minutes later according to the rules.

8. TIME LIMITS

8.1 Computing Time - Time is not checked on each shot. The time allowance is computed for a complete stage (including sighting shots when specified). In some cases this is on the basis of the specified number of shots multiplied by the allowance per shot. The Chief Range Officer may terminate any relay before completion of the full time allowed if all competitors in that relay have completed firing. Time allowed but not used does not carry over to another string or stage.

8.2 Time Allowance -

- (a) Time Limits - Shooting time including sighting shots is 1 ½ minutes per record shot prone and kneeling; and 2 minutes per record shot standing.
- (b) Changes to time limits must be stated in the tournament program. It is recommended that the competitors be given 15 additional minutes for each position change but in no case will less than 5 minutes be allowed for each position change. In matches of more than one stage when firing must cease to change targets, time may not be accumulated at one stage and used at another stage. Time for each stage will be allotted separately.

8.4 Passage of Time - The Range Officer must inform the shooters of time remaining at five (5) and two (2) minutes before the end of the shooting time.

8.5 Additional Time - It is the responsibility of the shooter to finish shooting within the time allowed. Additional time will not be given except as otherwise provided in these Rules. Any extension of time which is allowed by the Jury, Referee, or Range Officers will be clearly marked on the range register with the reason stated and will inform the shooter involved.

Note: Shots which are fired before or after the end of the official shooting time, or which are not fired at all, shall be registered as misses, unless the Jury, Referee, or the Range Officers have authorized extra time for the shooter.

9. COMPETITION REGULATIONS AND RANGE OPERATION

● **9.1 Changing Air Rifles** - No competitor will exchange an air rifle or the stock of the air rifle during the firing of any single or multiple stage match (except in aggregate matches), unless it has become disabled and has been so designated by the Chief Range Officer or Referee. For the purpose of this rule the firing of a match is considered to have started when the competitor has fired their first shot. A claim that an air rifle is disabled must be made immediately. All shots fired up to the time that the claim is made will stand as part of the official score.

9.1.1 Changing of compressed air or CO2 cylinders for any reason must be done behind the ready line.

9.2 Sighting Shots -

- (a) Sighting shots (unlimited in number) may be fired at any time after the command "COMMENCE FIRE" or "START" within the time limit for that match or stage. Once the first record shot in a position has been fired, no further sighting shots are allowed unless permitted by the Jury.
- (b) If a shooter must cease fire for longer than three (3) minutes due to no fault of his own, he may demand extra and equal time. If the interruption is longer than five (5) minutes, the shooter has the right to unlimited additional sighting shots. If a target change requires the shooter to move away from the firing point or get out of position the shooter has the right to unlimited additional sighting shots.
- (c) Unlimited additional sighting shots may be authorized in the event of a disabled air rifle. See Rules 9.5 and 10.13
- (d) A two point penalty will be given for each sighting shot fired after the first record shot except as authorized by the Jury.

9.2.1 Marking of Sighting Target -The sighting target must be clearly marked, normally, by means of a black stripe in the upper right corner which can be clearly seen with the naked eye. During competitions where double target frames are used, a broad black band will be hung over the face of the target which is not in use or the target not in use must be removed. If the 12-bull AR-5/10 target is used, the sighting targets are located in the center of the target and enclosed with a guard ring.

9.2.2 Misplaced Sighting Shots - When a multiple bullseye target (with sighting bullseye) is used, and the firer in his first fired shot of the target (sighting bullseye) misses the scoring area of the sighting bulls-eye or ring when printed on targets, the firer shall: halt firing, call a Range Official or Referee, have the official verify that the shot is not in the sighting bulls-eye. The official shall record this fact and the firer shall commence firing at the sighting bull again. The Range Official will continue to observe until the firer's shots hits the sighting bullseye. At this point the official will verify all previous shots (they will not be scored as misses) and the shooter will continue firing the match under the rules of the match. No extra time will be allowed for the procedure above. Additional shots outside the scoring rings will be scored as record shots. All penalties used in scoring shall be in force after the first shot that strikes the sighting bullseye.

9.3 (Blank)

9.4 Misfire - A misfire is a shot in which the pellet is not expelled from the gun. The Range Officer must be notified of a possible misfire before the next shot is fired. The Range Officer, when satisfied there is a misfire, will permit the competitor to continue firing. A competitor will be given the appropriate additional time to fire each misfire.

9.5 Disabled Air Rifle - Any air rifle which cannot be safely aimed or fired, or has suffered damage to the sights rendering it impossible to aim properly or which has a broken seal or cannot be fired because of mechanical failure may be declared a disabled air rifle by the Range Officer. There must be evidence of physical damage to the sights; the fact that the sights are improperly adjusted does not constitute disablement. If the air rifle fails to function, the shooter or coach must notify the Range Officer. A gun declared disabled by the Range Officer shall not be used again for firing until the defect has been corrected and the gun has been ruled safe by the Range Officer. When a gun has been declared disabled, the shooter will be given a reasonable period of time to repair the gun or continue firing with a substitute. When the shooter resumes firing, he/she will be given the amount of time that remained to be fired at the time the gun became disabled. The shooter will be given the opportunity for unlimited sighting shots within the allotted time remaining in accordance with Rule 9.2.

9.6 Malfunction - Failure of the rifle to function properly due to mechanical defect or to defective ammunition. Functional failures due to improper manual operation are not to be considered as malfunctions. (For procedure in case of a disabled rifle, see Rule 10.9.)

Note: Running out of air/CO2 in the middle of a stage does not constitute a disabled rifle or malfunction. No additional time will be given to restore the rifle to shooting condition. Low air pressure in the rifle caused by a damaged seal or leaks will be considered a malfunction. All other reasons will not be considered a malfunction or a disabled gun. If the shooter thinks his gun has malfunctioned, he must inform the Chief Range Officer who will make a decision on the rifle. All shots, up to the point of declaration of the malfunctioning rifle, will count.

9.7 (Blank)

9.9 Competitor's Position -A competitor will take his position immediately to the right of the numbered firing point marker except that left-handed shooters may be directed by the Range Officer to take position immediately to the left of the marker in order to avoid interference with other competitors. No portion of the shooter's body may rest upon or touch the ground forward of the firing line. This does not prohibit some equipment from being placed forward of the firing line. (See Rule 3.9 Shooting Kits).

9.10 Coaching Prohibited - During individual competition, coaching of any kind is forbidden while the competitor is on the firing line. As long as the competitor is on the firing line he may speak only with members of the Jury or with Range Officials, Coaches may assist shooters before the preparation period begins.

- (a) If a competitor wishes to speak with any other person, he must unload his air rifle, leave it in a safe condition on the line (or the firing bench) and leave the firing line only after notifying the Range Officer, then being careful not to disturb other competitors.
- (b) If a team official wishes to inform a shooter on the firing line of something which does not relate to the competition or "coaching" he must first obtain permission of a Jury member or the Official Referee.

9.11 Matches Not Complete -When a match or stage is not completed by all competitors in accordance with the tournament schedule, the match or stage may be rescheduled or cancelled. Any match or stage which has been completed by all competitors will not be refired. Only scores of a match or stage which has been completed will be included in an aggregate event, and a match or stage is not completed unless all competitors have fired.

9.12 (Blank)

9.13.1 Interference - With the exception of competitors actually firing and such range personnel as may be necessary, the firing points and lines will be kept clear at all times. Competitors will not be permitted to interfere with the handling of targets by range personnel.

9.14 - 9.22 (Blank)

9.23 Aliases - No competitor may fire under an assumed name nor substitute for another in a match; no competitor may register, enter or fire in the name of another.

9.24 (Blank)

9.25 Crossfires and Excessive Hits - No competitor will deliberately fire on the wrong target nor fire more than the required number of shots, including hits on some other competitor's target card. (Rules 14.7 and 14.10.)

9.26 Bribery - No person will offer a bribe of any kind to any of the range, statistical personnel, or others, nor be an accessory thereto.

9.27 Disorderly Conduct - Disorderly conduct or intoxication is strictly prohibited on the range and anyone guilty of same will be expelled from the range. Expelled competitors will be disqualified from that competition with no return of entry fees.

9.27.1 Willful Destruction of Range Equipment - No competitor shall cause any range equipment to become damaged through a deliberate act, and anyone guilty of same will be expelled from the range without a warning.

Expelled competitors will be disqualified from the competition with no return of entry fees.

● **9.28 Refusal to Obey** – No person will refuse to obey instructions of the Match Director, Official Referee, Range Officers or any other officer of the tournament, if instructions are given in the proper conduct of their office.

9.29 Evasion of Rules - No competitor will evade nor attempt to evade nor be an accessory to the evasion of any of the conditions of a match as prescribed in the program or in these Rules. Refusal of a competitor or Tournament Official to give testimony regarding facts known to him concerning violations or attempted violations of these Rules will constitute being an accessory to the violation or attempted violation.

● **9.30 Penalties/Disqualifications** - In cases of infringement and contravention of the regulations or of the instructions of Range Officers, the following penalties may be imposed upon the competitor by the Match Director, Referee or Jury.

Warning
Deduction of points from the score
Disqualification

In case of infringement of the regulations:

- (a) A warning may be given so that the competitor may have the opportunity to correct the fault. In case of a serious violation of safety regulations, the Jury or Referee has the authority to impose immediate disqualification.
- (b) If the competitor does not correct the fault before the next shot, 2 points shall be deducted from his score.
- (c) For a repeated infringement, the competitor may be disqualified.
- (d) A warning to the competitor must be expressed in such terms as will leave no doubt that it is an official warning. A warning to the competitor, whenever it is possible, should be given so as not to disturb him while firing a shot, unless the infringement concerns safety, in which case the competitor shall be warned immediately.
- (e) If a competitor continues to handle his firearm in a dangerous manner, or continues to violate any of the safety regulations, he may be disqualified.
- (f) If the Range Officer, Referee or Jury is of the opinion that the competitor has attempted to intentionally circumvent the rules or disturb other competitors in an unsportsmanlike manner, he may be warned, then penalized by the deduction of 2 points from his score, or he may be disqualified.
- (g) If the Range Officer, Referee, or Jury considers that the competitor is holding up the procedure unnecessarily, with the intention of gaining unfair advantage, he may be warned, then for every similar fault thereafter; 2 points may be deducted from his score.
- (h) The discharge of any firearm any place other than the firing line, or the firing line prior to the shooter being placed in the preparation period, will result in disqualification and expulsion from the tournament with no refund of fees. If a firearm is discharged while the shooters are in the preparation period prior to the command "LOAD," it will result in the competitor being disqualified from that fired match.
- (i) Any competitor placing a pellet in the chamber on the loading ramp before the command : "LOAD" or COMMENCE FIRING," will be warned on the first violation, disqualified from that stage for the second violation, disqualified from the match for the third violation, and expelled from the tournament of the fourth violation, with no refund of fees.

All irregularities, penalties, misses, malfunctions, extra time allowed, repeated shots or repeated series, annulment of shots, etc., must be clearly marked and recorded on both the target and score card, by the responsible official on the range. Penalty points will be deducted from the stage or match in which the infraction has occurred, starting from the last bull fired in the stage or match.

10. RANGE CONTROL AND COMMANDS

10.1 Discipline -The safety of competitors, range personnel and spectators requires continuous attention by all to the careful handling of air rifles and caution in moving about the range. Self-discipline is necessary on the part of all. Where such self-discipline is lacking it is the duty of range personnel to enforce discipline and the duty of competitors to assist in such enforcement. Under no circumstances shall firing commence or continue on a range where an unsafe condition exists.

● **10.1.2 Air Rifles Unloaded** - Air Rifles will not be loaded until the competitor has taken position at his assigned firing point; air rifles are pointed toward the targets; and the command," COMMENCE FIRE" or "START" has been given.

10.1.3 Loaded Air Rifles - No pellet will be inserted into the air rifle except at the firing point and after the command, "COMMENCE FIRE" or "START". The muzzle of the air rifle will be pointed in the direction of the targets until the air rifle is discharged or unloaded. Even if a rifle has a magazine, only one pellet may be loaded.

10.1.4 Cease Firing -

- (a) Cease Firing - All shooters will immediately stop firing upon the command "CEASE FIRING" or "STOP". Actions will remain open (See Rule 14.5). "Cease" is the preparatory part of the command and "Firing" is the action part of the command. NO shot should be fired after the word "Firing" is spoken.
- (b) Commence Firing - All shooters may start firing upon the command "COMMENCE FIRING" or "START" as the timing of the string is started with this command (See Rule 14.5). "Commence" is the preparatory part of the command and "Firing" is the action part of the command. NO shot will be fired before the word "Firing" is spoken.

10.1.5 Not Ready - It is the duty of competitors to notify the Range Officer if not ready to fire at the time the Range Officers asks "IS THE LINE READY?" Should the Range Officer cause firing to proceed, the competitor concerned will be given an opportunity to fire his score in the earliest possible relay or by time extension in his relay. Failure of competitor to notify the Range Officer that he is not ready forfeits his right to fire.

10.1.8 Disturbance of Competition - Should a competitor consider that he was disturbed while firing a shot, he must put down his air rifle and immediately make his claim to the Range Officer or Jury Member, without disturbing the other competitors.

- (a) If the claim is considered justified, the shot will be annulled and the competitor will be allowed to repeat the shot.
- (b) If the claim is considered not justified, the shot will be credited to the competitor.

10.1.9 Target Mounting -

- (a) When a range is equipped with a carrier system permitting the changing of targets from the firing line without suspending the firing, competitors may be issued the targets necessary to complete the match. Each competitor will be responsible for hanging his target properly on the target carrier and may, if provided for in the tournament program, remove the fired target under supervision of the range officials. Fired targets will be gathered by the Range Officer as soon as each stage is completed.
- (b) When carrier systems are not used, each competitor may be required to hang his target properly and remove his or another competitor's fired target under supervision of the range officials, if provided for in the tournament program.
- (c) When targets are framed (mounted) by persons other than the competitors, competitors must be given the opportunity to observe their assigned targets and verify they are clean and of the correct type before the command to load is given.

10.2 Loud Language - Loud or abusive language will not be permitted. Competitors, Scorers, and Range Officers will limit their conversation directly behind the firing line to official business. (Rules 9.13.1 and 10.3.2)

10.3 Delaying a Match - No competitor may delay the start of a match through tardiness in reporting or undue delay in preparing to fire.

10.3.1 Preparation Period - In all cases competitors will be allowed 3 minutes to take their places at their firing points and prepare to fire after the firing point has been cleared by the preceding competitor. Dry firing shall be permitted during this period.

10.3.2 Interrupted Fire - If for any reason such as safety or technical problems the shooting is interrupted through no fault of the competitor and if the time elapsed is more than 5 minutes, or if the shooter must move his equipment to another firing point the Jury/Referee will allow unlimited additional sighting shots.

● **10.4 Policing Range** - It is the duty of competitors to police the firing points after the completion of each stage and to dispose of any garbage. The Range Officers will supervise such policing and will see that the firing points are kept clean.

10.5 Competitors Will Score - Competitors will act as scorers, when requested to do so by the Match Director or Chief Range Officer, except that no competitor will score his own target.

10.6 Repeating Commands - A Range Officer will repeat the Chief Range Officer's commands only when those commands cannot be heard clearly by competitors under his supervision.

● **10.7 Firing Line Commands** - When ready to start the firing of a match the Range Officer commands:

“RELAY NO. 1 MATCH NO. (or naming the match) ON THE FIRING LINE.”

Once shooters have been given enough time to get to their firing points, the Range Officer will state: **“GO FORWARD AND HANG YOUR TARGETS.”**

When all shooters have returned from downrange, the Range Officer commands: **“THE PREPARATION PERIOD STARTS NOW.”**

Shooters will have a minimum of 3 minutes to make their last minute preparations. Shooters may dry fire during the preparation period. Range Officers should check the location of each competitor as to correct firing point by comparing the number of each competitor's firing point with the relay and target number on his scorecard or on the range assignment card. At the end of 3 minutes, the Range Officer states: **“THE PREPARATION PERIOD HAS ENDED.”**

Next the Range Officer asks the question: **“IS THE LINE READY?”**

A competitor who is not ready will immediately raise his/her arm and call, **“NOT READY ON TARGET! ‘ _____ ’”** The Range Officer will immediately state: **“THE LINE IS NOT READY,”** proceed to investigate the difficulty and assist in correcting it. When this has been corrected, the Range Officer calls: **“THE LINE IS READY, YOU HAVE ‘ _____ ’ MINUTES, COMMENCE FIRING”.**

(Note: Time will vary depending on course of fire.)

After this command, firing commences and competitors have the stated time to complete their firing. At the end of the firing period, the Range Officer commands: **“CEASE FIRE. MAKE THE LINE SAFE. INSERT CBI”**

11. TOURNAMENT OFFICIALS

Tournament Officials-Officials will be thoroughly familiar with conditions of the program and with National Rifle Association Rules. The Match Director, Deputy Match Director, Chief Range Officer, Chief Statistical Officer, and Official Referee should not compete in any Registered Tournament where they are officiating.

● **11.1 Match Director** -The Match Director is directly responsible for the efficient conduct of the entire tournament. He may change the match and firing conditions as shown by the program provided a bulletin is posted for the information of all competitors, and that such changes are not contrary to current NRA Rules. He is directly responsible for the efficient operation of the range and the Statistical Office and for the safety and proper discipline of all tournament operating personnel, competitors, and spectators. Instructions from the Match Director for the operation of the tournament will be complied with by all persons on the range. The Match Director will use his best judgment at all times and his behavior and decisions must be characterized by absolute impartiality, firmness, courtesy and constant vigilance. In the application of these rules the Match Director will confer with the NRA Official Referee or Jury on any doubtful point and will be guided by the Official Referee's, or Jury's decision.

11.1.1 Deputy Match Director -The Deputy Match Director, when appointed, is responsible to the Match Director for the efficient conduct of the entire tournament, and acts for the Match Director in all matters listed in Rule 11.1. A Deputy Match Director is appointed at the discretion of the Sponsor.

11.2 Official Referee - An Official Referee will be assigned to all NRA Championships and may be assigned to Regional, Sectional and State Championships. Assignments are made from NRA Headquarters. The NRA Official Referee is not an administrative or operating official. It is his responsibility to see that all National Rifle Association Rules are properly interpreted and applied. It is his duty to rule on all protests and challenges presented to him. His decisions on challenges as provided for herein are final. He will not score except when called upon to rule on challenges. (Rule 16.1).

11.2.1 Jury - In all Registered Tournaments other than National Championships, a three person Jury may be formed by the Match Director to see that all National Rifle Association Rules are properly interpreted and applied. One member of the Jury must be a member of the sponsoring organization and complete the reports required by the NRA. The members of the Jury may or may not be competitors in that tournament. A Jury member shall exempt himself from ruling on a matter in which he is personally involved. The Match Director will name a replacement for that Jury member while ruling on that action. Under no circumstances may any Match Official (Rules 11.1, 11.4, 11.5, 11.6, 11.7) be a member of the Jury.

11.3 -BLANK

11.4. Range Director -When appointed, the Range Director and Deputy Director are responsible to the Match Director, and have supervisory responsibility for the Chief Range Officers and for the efficient and safe operation of the ranges. Appointment of a Range Director and Deputy Range Directors is authorized when multiple ranges are in operation.

11.4.1 Chief Range Officer - Will have full charge of the range and will conduct the matches on schedule approved by the Match Director. He is responsible for range safety and for enforcing all rules.

11.5 Range Officers - Each Range Officer is an assistant to the Chief Range Officer. Competitors may be assigned this duty. He is responsible for the safety and discipline of range personnel, competitors, and spectators in the sector of the range to which he has been assigned. He shall make a signed notation on a target which has a crossfire, and an allowed double hit, or any circumstance in which his notation would be of assistance to the Statistical Office. He is responsible for seeing that the competitor's equipment and position are authorized for the particular match being fired. It is his duty to be completely familiar with the program and with the National Rifle Association Rules. He is to comply to the best of his ability with all instructions issued by the Match Director or Chief Range Officer and will render all possible cooperation to other officials. He must be constantly alert, impartial in his handling of competitors, courteous, and firm.

11.6 Statistical Officer -The Chief Statistical Officer is in charge of the scoring of all targets and statistical work in connection with the match. The Statistical Officer is directly responsible to the Match Director. He may be assisted by such Assistant Statistical Officers as may be required.

11.6.1 Duties of Office - It is the duty of the Statistical Office to:

- (a) Register competitors and check their eligibility and classifications.
- (b) Accept match entries.
- (c) Prepare, post and keep current a list of competitors showing name, number and classification.
- (d) Squad competitors and prepare range assignment cards where such cards are used.
- (e) Prepare official scorecards.
- (f) Check addition on scorecards and correct totals.
- (g) Score targets and tabulate
- (h) Prepare Preliminary and Official Bulletins.
- (i) Maintain an Official Bulletin Board.
- (j) Determine award winners and distribute awards.
- (k) Report to NRA Official Referee and Match Director for appropriate disciplinary action any irregularities in firing or scoring which may be indicated by squadding records or scorecards.
- (l) Make required reports to NRA within specified time.

11.6.2 Retention of Records -The Statistical Office will retain in good order all completed official scorecards for 30 days, and all fired targets until the expiration of the time allowed for challenges and protests.

11.6.3 Preliminary Bulletins - Preliminary Bulletins on all matches will be posted promptly on the Official Bulletin Board and remain a reasonable length of time to allow competitors or coaches to notify the Statistical Office of apparent errors. The challenge closing time will be stated on each bulletin. However, where a bulletin board is used and all scores of shooters are copied thereon, such will be accepted in lieu of the above provided a notice appears as to the close of challenge time.

11.6.4 Official Bulletins - Official Bulletins will be posted on the Official Bulletin Board. However, in the procedure outline in Rule 11.6.3 for bulletin boards, such scores shall be acceptable and become final at the end of the challenge time period and shall act as an Official Bulletin.

11.6.5 Correction of Bulletin Errors -The Statistical Office will correct errors which come to the attention of the office prior to publication of the Official Bulletin.

● **11.6.6 Changing Official Bulletins** -No Official Bulletin shall be changed except on authority of the Official Referee, Jury, or Match Director granted before the time has expired for challenging the last of the Preliminary Bulletins required to cover all the scheduled events. Subsequent changes from the Match Director, Official Referee or Jury requesting a change, are limited to correction of:

- (a) Typographical errors.
- (b) Aggregate bulletin on which total score does not agree with scores shown on the Official Bulletins for the matches constituting the aggregate.
- (c) Where an error has been made by not following the program schedule of awards.
- (d) Errors in classification of shooter, the shooter having been previously advised of such error and of correct classification.
- (e) Disqualification of shooters as provided by Rule 9.30.

11.6.7 Individual Squadding - Where advance entries are received, squadding for all matches may be made in advance. Competitors may be squadded so they move a predetermined distance along the firing line after each

match. They may be squadded as to class, but wherever practical all of a class should fire on the same relay. Where post entries are received, they may be squadded as fill-ins to the above. Squadding of classes together will be permitted as outlined above.

11.6.8 Team Squadding - All team matches will be squadded with one or two adjacent targets assigned to each team and where possible all teams will fire concurrently. When enough targets are available more than two adjacent targets may be assigned each team but only when teams can be squadded so as to fire concurrently. Coaching within the team is permitted in team matches, therefore not more than two adjacent targets will be assigned each team unless all Team Captains indicate their willingness to use more than two targets.

Team targets may be assigned by the Statistical Officer, or drawn by chance by the Team Captains under the supervision of the Statistical Officer or Chief Range Officer.

Team scorecards will show the names of Team Officers, and each firing member and alternate.

Except in matches where the targets have been marked with the competitor's name and number, Team Captains may assign team members to team targets in such order as he desires and may change the order of firing of team members as he sees fit.

11.6.10 Range Assignment Cards -When used, range assignment cards are prepared by the Statistical Office and delivered to the Range Officers prior to each match. Range Officers check competitors on the firing line to ascertain that each is on the proper firing point as indicated by the range assignment card. These cards will be turned in to the Statistical Office immediately upon the conclusion of each relay.

11.7 Target Officer - The targets and frames are under the command of the Chief Target Officer and such Assistant Target Officers as may be required. Target Officers are under the command of the Chief Range Officer. The Target Officer is responsible for the safety and discipline of personnel engaged in handling of the targets. He is responsible for the maintenance of the targets in proper condition and for the efficient mounting and dismounting of paper targets during the progress of the match. When targets (either with or without backing cards) are framed (mounted) for the competitor, the Target Officer is responsible:

- (a) That record and backing target, if used, agree.
- (b) That targets are properly framed as to firing point assignments.
- (c) That after firing, all targets and backing cards are properly dismounted and paired according to target point number, in proper order.
- (d) That targets are arranged in numerical order.
- (e) That all targets are returned promptly to the Statistical Office at the completion of each relay or displayed on racks in proper order. When targets are framed by the competitor it is the competitor's responsibility that the correct target for the range and position being fired is framed.

11.8 National Championship Protest Committee - A National Championship Protest Committee may be appointed by the Match Director of any NRA National Championship. (See Rule 16.2.1.) When such a Championship Protest Committee is appointed, decisions on Protest by that Committee at that Championship are final, without appeal to the NRA Protest Committee. When possible cases of suspension from competition arise from an incident in a Championship, the Championship Protest Committee may not act, but must forward a recommendation to the NRA Protest Committee for action. No member of the National Championship Protest Committee may be a competitor in that tournament.

11.9 Duty to Competitors - It shall be the duty of all operating officials and personnel to conduct themselves properly by being fair and impartial to all in carrying out their various duties. No official shall molest a competitor nor allow such practice by another official or other competitors. Should a shooter's equipment or demeanor warrant disqualification for an individual match or tournament, it should be done in such a manner as to cause the least inconvenience to all concerned. In so doing, the official should state to the competitor the rule or section of rules under which the disqualification is being made. (See Rule 16.2.)

12. TEAM OFFICER'S DUTIES AND POSITION

12.1 Team Captain - Each team must have a designated Team Captain. He is responsible for maintaining discipline within his team. He will at all times cooperate with the officials of the tournament in the interest of safety, efficiency and good sportsmanship. A Team Captain is responsible for all the duties and actions of the members of his team. It is his responsibility to:

- (a) Be familiar with the program.
- (b) Make proper entries.
- (c) Have team members report at the proper firing point at the right time, ready to fire.
- (d) Perform usual coaching duties.
- (e) Check team scores, sign team scorecards and make challenges.
- (f) Check Preliminary and Official Bulletins and Match Director's Bulletins.
- (g) Make protests.
- (h) Collect awards.

12.2 Team Coach - The Team Coach is the Team Captain's deputy, performing such duties as the Captain may assign to him. The Coach serves as Team Captain in the absence of the latter, and under such circumstances becomes responsible for maintaining discipline within the team and for all other responsibilities of the Team Captain.

12.3 Team Entries - In team matches, the Team Officers, all firing members of the team, and alternate firing members if allowed by the match program must be named on the entry form before the first shot of the match is fired. If the Team Captain or Coach is also a firing member, he must be so named. (See Rule 2.10.)

12.4 Substitution of Alternates -If alternates are allowed and have been named on the entry form, the Team Captain may substitute an alternate for a firing member at any time before the firing member concerned has fired his or her first shot of the match (sighting or record), notifying the scorer and a Range Officer accordingly. After a team member has fired the first shot, he/she may be substituted for only in case of disabling emergencies such as accident or illness, and then only if approved by the Chief Range Officer. All shots fired by the replaced shooter count; the replacement fires only the uncompleted portion of the replaced shooter's course of fire.

12.5 Team Captains and Coach, Position - In team matches where coaching is permitted by the match program, the Team Captain or Coach will be allowed on the firing line in such position as not to interfere with the proper operation of the range or with any member of another team.

12.6 Coaching in Team Matches - Coaching on the firing line is permitted only when clearly stated in the match program of NRA team matches and must be kept within the team (a team shall include the Team Captain, the Team Coach and the team firing members). The Coach may assist the team members by calling shots, checking time, checking scoring, ordering sight changes, etc., but will not physically assist the shooter in loading, cocking the air rifle or making sight corrections. He must control voice and actions so as not to disturb other competitors.

13. PHYSICALLY DISABLED SHOOTERS

13.1 Physically Disabled Shooters - A shooter who, because of physical handicap, cannot fire from one or more of the prescribed shooting positions outline in these Rules, or who must use special equipment when firing, is privileged to petition position in the NRA Protest Committee for permission to assume a special position or to use modified equipment, or both. This petition will be in the form of a written request from the person concerned to the Committee outlining in detail the reasons why the special equipment must be used. The petition will be accompanied by pictures of the shooter in the position he desires approved and, if special equipment is required, the pictures will show how this equipment is used. The petition and all pictures must be furnished in exact duplicate. The petition must be accompanied by a medical doctor's statement if the physical handicap is not completely evident in the pictures submitted.

- (a) Each petition will be reviewed by the NRA Protest Committee. The Committee may require additional or supplementary statements, medical information or pictures. If approved, the NRA Secretary will issue a special authorization certificate to individual concerned. Such certificates will have necessary pictures attached.
- (b) Shooters who have received special authorization certificates will be required to carry them when competing in competitions governed by NRA Rules, and to present the certificates when requested by officials of the competition or by NRA Official Referees or Supervisors.
- (c) In the event of a protest involving the position or the equipment used by such a shooter, the Official Referee, Jury or Match Director will compare the questioned position or equipment with the certificate and photographs presented by the shooter. If the shooter's position or equipment does not, in the opinion of the officials, conform to that authorized by the NRA Secretary (or if the shooter has no authorized certificate or pictures), the protest shall be allowed and the shooter will be required to change immediately to the position or equipment which has been approved or to an otherwise legal position or equipment.
- (d) Should a protest be carried beyond the Official Referee, Jury or Match Director, the original protest will be endorsed by the Referee, Jury Chairman or Match Director to show the action he has taken and will be forwarded to the National Rifle Association.
- (e) National Records may not be established by use of scores fired in special positions or with special equipment as may be authorized according to this Rule.
- (f) Two types of authorizations are issued; temporary and permanent. Permanent authorizations are issued to competitors who are permanently handicapped.

13.2 Temporary Disability and Substitute Position - Any person who has a temporary physical disability, as substantiated by a current written medical opinion, which prevents him from using a specified position as defined in this Rule, may assume the next more difficult position in lieu of that position. In this manner, kneeling may be used for prone, and standing may be used for kneeling. Any substitute position must conform to the rule which defines it. The Match Director must be informed of the substitute, and may require that the substitute position be demonstrated so he may be certain that it meets the definition of the appropriate rule.

14. SCORING AND MARKING

14.1 When to Score - Usually targets are scored after 10 shots or after 20 shots. Special conditions may require other than this usual procedure. Before scoring any target, examine it and count the hits to determine whether there are hits of uncertain value requirement gauging, misses, or possible ricochet hits.

14.2 Where to Score -Targets may be scored in the Statistical Office or on the range in view of competitors and spectators.

14.2.1 Targets As Scorecards -Targets constitute the scorecards when scored in the Statistical Office and therefore must be retained in good order until the time allowed for filing challenges and protests has expired.

14.3 How to Score - A shot hole, the lead edge of which comes in contact with the outside of the bullseye or scoring rings of a target, is given the higher value. If a competitor fails to hit any target (shot/s outside the scoring ring) that shot will be scored a miss (zero). A scoring gauge will be used to determine the value of close shots. The higher value will be allowed in those cases where the flange on the gauge touches the scoring ring, see Figure 7, except that when the Air Rifle "outward" scoring plug gauge is used, the higher value is awarded when the flange fails to touch the outside edge of the next scoring ring out, see Figure 8. All shot holes with an estimated value greater than 2 shall be scored with the outward gauge (b) described below.

No scoring gauge will be used unless the diameter of the scoring flange is within these limits:

- (a) Air Rifle, .177-.179 (4.5-4.55 mm).
- (b) Air Rifle gauge for "outside" scoring, 5.45-5.50 mm.

In figure 8a the "A" illustration depicts a doubtful shot hole to the scorer. The 5.5 mm outward scoring gauge in place, the outside edge of the flange is within the 7 ring, therefore the shot would be scored a 9.

The "B" illustration depicts a doubtful shot hole to the scorer. The 5.5 mm outward scoring gauge shows the outside edge of the flange lying over the 7 demarcation line and into the 6 ring, thereby giving a result of 8.

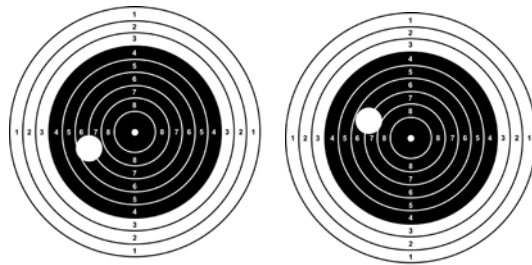

See Illustration The Correct Method of INSIDE Scoring
The shot on the left bullseye counts 7, the one on the right, 8.

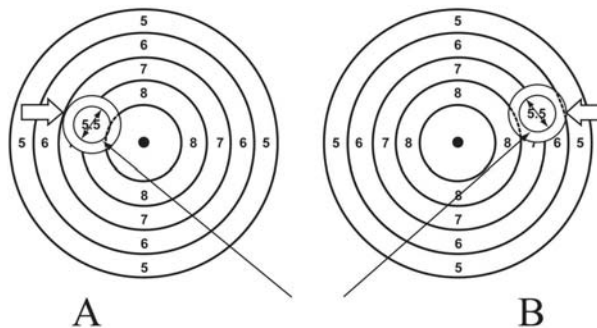

Correct Use of Air Rifle OUTWARD Scoring Gauge
The Correct Method of Scoring
The shot on the left counts 9, the one on the right counts 8.

● **14.3.1 Use of Plug Type Scoring Gauges** - Shots in dispute shall be scored with the aid of a “plug” type scoring gauge. When the accurate use of a plug is made difficult by the close proximity of another pellet hole or torn paper, the shot value shall be determined by means of an engraved gauge of some flat, transparent material to aid in reconstructing the position of a scoring ring or number of pellet holes which may develop or a magnifying device with the same dimensions target specified.

- (a) Except as provided herein, the plug gauge may be inserted only once in a pellet hole.
- (b) When two scorers agree, they shall indicate their decision by writing “+” or “-” on the target. Both scoring officials shall initial the target.
- (c) When the two initial scorers disagree, a decision from a scoring supervisor shall be requested immediately and before the plug is removed. After inspecting the plugged shot hole, the Chief Statistical Officer shall indicate his decision by writing “+” or “-” on the target to indicate whether the shot goes to the higher or lower value. All three scoring officials shall initial the target.
- (d) No challenge may be made against a shot value which has been determined with the aid of a plug gauge except:
 - (1) in air rifle competitions where two scoring officials are not used to evaluate plugged shots;
 - (2) targets which do not bear the appropriate “+” or “-” markings and initials may be challenged and re-plugged;
 - (3) if the value of the shot is incorrectly noted based on the “+” or “-” decision.

14.3.2 Scoring Inner Tens - Inner tens must be scored when necessary to break ties. (See Rule 15.3.) Air Rifle 10 meter targets (AR-5/1, AR-5/5, AR-5/10) inner tens are scored as follows: when the ten ring (dot) has been shot out completely as determined by the use of a 4.5 mm air rifle plug gauge.

14.3.3 Electronic Scoring - Electronic scoring machines are authorized.

14.4 Misses - Hits outside the scoring rings are scored as misses. Any release of the propelling charge, after the first competition target is in place, without the pellet hitting the target, whether a pellet has been loaded or not, will be scored as a miss.

“Dry Firing” means the release of the cocked trigger mechanism of an unloaded rifle or the release of the trigger mechanism of a gun fitted with a device, which enables the trigger to be operated without discharging the gun.

14.5 Early or Late Shots - If any shots are fired before the command to “COMMENCE FIRING,” or after the command to “CEASE FIRING,” the shots of highest value equal to the number fired in error will be scored as misses.

14.6 All Hits Count - All shots fired by the competitor (hits outside the sighting bull) after having taken a position at the firing point will be counted in his/her score, even if the rifle is accidentally discharged, except the first sighting shot on a target.

14.7 Hits on Wrong Target -

- (a) If a competitor fires a sighting shot on the sighting target of another competitor, he shall not be penalized.
- (b) If a competitor fires a sighting shot on the record target of another shooter, he shall be penalized by deduction of two points from his own score.
- (c) Any crossfire of a record shot onto another shooter’s target will be scored as a miss (zero).

14.8 Ricochets - A hole made by a ricochet pellet does not count as a hit and will not be scored.

14.9 (Blank)

14.10 Excessive Hits -

- (a) If a competitor fires more shots on a record bullseye than provided for in the program, he shall not be penalized for the first two (2) occurrences. For the third (3rd) and all succeeding shots, he shall be penalized by the deduction of two points for each occurrence, starting with the first target in the series/position. The competitor must fire a correspondingly fewer number of shots at the succeeding bullseye in the same match.
- (b) If there are more hits on a shooter's record target than are provided for in the program, and it is impossible to confirm that another shooter(s) fired the shot(s), than corresponding to the number of surplus shots, the hits of highest value shall be nullified. When using AR-5/10 or AR-5/5 targets, the nullified hit will come from the target with the extra shots. when using AR5/1, electronic targets, or rolls of targets, the extra shots at the end of the string will be nullified.
- (c) If a competitor wishes to disclaim a bullet hole on his target, he will report this immediately to the Range Officer. If the Range Officer cannot confirm beyond all reasonable doubt that the competitor did not fire the disputed shot(s) the shot will be credited to the competitor and will be so recorded. The following shall be considered sufficient to justify the annulment of a shot:
 - (1) If the Scorer confirms by his observation of the competitor and the target that the competitor did not fire the shot.
 - (2) If a "missed shot" is reported by another competitor or scorer at approximately the same time, and from within the neighboring two or three shooting stations.
- (d) If a shooter received a confirmed crossfired shot and it's impossible to determine which shot is his, he will be credited with the value of the highest undetermined shot.

14.11 Scoring Altered Targets -Targets intentionally altered, or marked to benefit a shooter over other competitors, will not be scored.

15. DECISIONS OF TIES

15.1 Match - The term "match" as used in this section refers to all individual, team, and aggregate matches.

15.2 Numbering of Bullseyes - For the purpose of ranking tie scores, the bullseye numbers printed on NRA official targets will be considered to run in consecutive sequence throughout the entire course of fire, even though all targets for an event may not be framed at one time.

15.3 Breaking Tie Scores - Competitors having the same numerical score over the entire course of fire will be ranked in order:

- (a) The highest score of the last 10 shots fired working backward by 10-shot-strings until the tie is broken.
- (b) The highest number of 10's, then 9's, then 8's, etc.
- (c) The highest number of inner 10's.
- (d) Ties for the 9th through all remaining award placing will be broken as in Rule 15.3(e) except that if the tie still cannot be broken in this manner, the competitors will be listed with equal rank, in alphabetical order using the competitor's surname. An appropriate number of spaces will be left vacant below the tied position before the next ranking is listed.
- (e) Ties occurring below the final award winning place will be listed with equal rank in alphabetical order using the competitor's surname. An appropriate number of spaces will be left vacant below the tied position before the next rank is listed.

15.5 (Blank)

15.7 Team Matches - Ties in team matches will be ranked in the order shown below:

- (a) By considering team score as though it were a single individual score fired by an individual.
- (b) Apply Rule 15.3 to the total score.
- (c) If a team score includes a score achieved on a written test, by considering only the fired score.

15.17 Unbreakable Ties - In case a tie cannot be ranked as provided in this section the Match Director will direct that duplicate awards be given.

16. CHALLENGES AND PROTESTS

● **16.1 Challenges** - When a competitor feels that a match fired by himself or by another competitor has been improperly evaluated or scored, the competitor may challenge the score. A challenge must be made within the challenge time. It shall be the challenging person's privilege to inspect the target during or following the re-check.

- (a) A challenge fee of not more than \$3.00 may be charged to all competitors making challenges. The challenge fee will be collected before making the first re-check of the challenged score. If the competitor's challenge is sustained at any point along the line of re-checks, the challenge fee will be returned. If the challenge is lost, the challenge fee will be included in the general revenue of the tournament. In NRA competition to which the NRA assigns a Referee, or Jury, the decision of the Official Referee, or Jury will be final.
- (b) It shall be the responsibility of the tournament sponsor to state in the program or by Special Bulletin Board notice the time limits within which a challenge may be made.
- (c) When targets are scored in the Statistical Office or on display racks, the re-checks will be made by the Chief Statistical Officer (provided he has not previously scored or checked the target) and the Official Referee, or Jury in that order.
- (d) The Match Director may at his discretion re-check any competitor's target by an administrative challenge. Such a challenge must be made within the posted challenge period and checked by the Referee or Jury.
- (e) Fired matches are challenged by total score, not individual shots, targets or stages.

16.1.1 Administrative Challenges - Competitors may request the Chief Statistical Officer to verify addition of scores without payment of a fee. If a competitor discovers a discrepancy between the value marked on a target and the score recorded on a scorecard, scoreboard, result list or bulletin, he may request the Chief Statistical Officer to verify the score. Provided that no scoring challenge is made with respect to the evaluation of the target, the score marked on the target will be considered accurate and the scorecard, scoreboard, result list or bulletin will be corrected.

16.2 Protests - A competitor may protest formally:

- (a) Any injustice which the shooter or coach feels has been done except the evaluation of a target, which he/she may challenge as outlined in Rule 16.1
- (b) The conditions under which another competitor has been permitted to fire.
- (c) The equipment which another competitor has been permitted to use.

16.2.1 Authority of Protest Committee - National Championships Protest Committees or juries may be established at National Championships to rule on protests arising from activities at those sites. (See Rule 11.8.) However, the decisions of these special protest committees or juries shall not contravene prior interpretations of the NRA Rules and/or precedents established by the NRA Protest Committee.

● **16.3 How to Protest** - A protest must be initiated immediately upon the occurrence of the protested incident. Failure to comply with the following procedure will automatically void the protest:

- (a) State the complaint orally to the Chief Range or Chief Statistical Officer. If not satisfied with his decision then,
- (b) State the complaint orally to the Official Referee, or Jury Chairman. If not satisfied with his decision then,
- (c) File a formal protest in writing with the Official Referee, or Jury Chairman stating all the facts in the case. Such written protest must be filed within 12 hours of the occurrence of the protested incident.
- (d) The Official Referee, or Jury will then forward the protest with a complete statement of facts within 48 hours of receipt thereof to the Protest Committee at NRA Headquarters.

- (e) At National Championships, a competitor must state his complaint orally to the Chief Range Officer or Chief Statistical Officer and if not satisfied with his decision, the competitor must file a written protest with the Match Director. If the competitor is not satisfied with the Match Director's decision on the matter, the Match Director will forward the protest to the Protest Committee along with a written statement of his decision. The decision of the Protest Committee at the National Championships is final. A protest procedure must begin no later than one hour after the completion of firing for the day. In the case of awards, the protest must begin no later than one half hour after the completion of the awards ceremony.

16.4 Challenges and Protests in Team Matches -

- (a) Must be made by the Team Captain. Team members who believe they have reason to challenge or protest will state the facts to their Captain who will make the official challenge or protest if he/she feels such action is justified.
- (b) It shall be the responsibility of tournament sponsors to state in the program or by Special Bulletin Board notice that team challenge fees shall:
 - (1) Not exceed \$3.00 per team score, or,
 - (2) Not exceed \$3.00 per team member's score.

17. NRA NATIONAL RECORDS

NRA National Records shall be established only by American citizens who are NRA members or Junior members of NRA affiliated clubs..

National Records may be established only when competition exist, i.e., more than one competitor or team in an event.

NOTE: In order for records to be reorganized promptly, National Record Reporting forms must be submitted to NRA by the Statistical Officer of the Tournament after being certified by the Jury accompanied by the targets and tournament result bulletin. National Record Reporting forms are mailed to sponsors of NRA Registered Tournaments by NRA Headquarters.

17.1 Where Scores for National Records Can Be Fired - To be recognized as National Records, scores must be fired in an NRA Registered Tournament. National Records must be approved by the NRA before being declared Official.

17.2 Scores Used - Scores must be complete scores for an entire scheduled match. Stage scores or scores for only part of a match will not be used for records.

17.3 Scores for National Individual Records - Such scores may be fired in individual matches. National Records will be recognized only when the competitor has entered such match.

17.4 Scores for National Team Records - Such scores must be fired in matches where teams fire as a unit representing an NRA affiliated organization. National Records will be recognized only when the team concerned entered such a match. National Records will not be recognized for "pick up" teams (teams made up of shooters who do not all represent one of the groups outlined in Rules 2.11).

17.5 Courses of Fire for Which National Records are Recognized -

Note: National Precision Air Rifle Records are maintained for scores fired with metallic sights over the following courses for "Open, Civilian, Women, Senior, JROTC, Military Veteran, Junior, Intermediate Junior, and Sub-Junior.

(a) Individual Position:

- (1) 20 Shots Prone
- (2) 40 Shots Prone
- (3) 20 Shots Kneeling
- (4) 40 Shots Kneeling
- (5) 20 Shots Standing
- (6) 40 Shots Standing
- (7) An aggregate of 20 Shots each in Prone, Kneeling & Standing
- (8) An aggregate of 40 Shots each in Prone, Kneeling & Standing

(b) Four (4) Member Team:

- (1) Team aggregate in 3-Position (Prone, Kneeling & Standing) 20 shots each
- (2) Team aggregate in 3-Position (Prone, Kneeling & Standing) 40 shots each

18. COMPETITORS' DUTIES AND RESPONSIBILITIES

Note: The following competitors' duties are in addition to those specified elsewhere throughout these Rules.

18.1 Discipline - It is the duty of each shooter and coach to sincerely cooperate with tournament officials in the effort to conduct a safe, efficient tournament. Shooters and coaches are expected to promptly call the attention of proper officials to any infraction of rules of safety or good sportsmanship. Failure of a shooter or coach to cooperate in such matters or to give testimony when called upon to do so in any case arising out of infractions of these Rules may result in said shooter or coach being considered as an accessory to the offense.

18.2 Knowledge of Program - It is the competitor's responsibility to be familiar with the program. Officials cannot be held responsible for a competitor's failure to obtain and familiarize himself with the program. When targets are framed by the competitor, it is the competitor's responsibility to mount the correct target for the range and position being fired.

18.3 Eligibility - It is the competitor's duty to enter only those events for which he/she is eligible and to enter himself in the proper classifications.

18.4 Classification - It is the competitor's duty to have his current Classification Card in his possession when entering a competition using a classification system. Unclassified competitors must obtain a Score Record Book from the Official Referee, Supervisor, or Tournament Officials.

18.5 Individual Entries - In individual matches it is the duty of the competitor to make his or her own entries on the forms and in the manner prescribed for that tournament. Errors due to illegibility or improper filling out of the forms are solely the competitor's responsibility. The Statistical Office is not required to accept corrections after the entry closing time.

18.6 Squadding Tickets - It is the duty of the competitor to secure his squadding ticket of each match (or to consult the squadding bulletin) in ample time to permit reporting at the proper time and place to fire each match. It is not the duty of officials to page competitors in order to get them on the firing line. Competitors, upon receipt of squadding tickets, should inspect them for correctness of competitor's number and non-interference in squadding assignment. Errors should be reported to the Statistical Officer immediately.

18.7 Reporting at Firing Point - Competitors must report at their assigned firing point immediately when the relay is called by the Range Officer. The proper rifle for that particular match must be ready and in safe firing condition. Time will not be allowed for rifle repairs, or search for missing equipment after a relay has been called to the firing line. (See Rule 10.1.5).

18.8 Timing - The timing of the firing of a stage (within the official time limit) is the competitor's responsibility. See Rule 8.4.

18.9 Loading - No competitor will load an air rifle except at the firing line, and only after the proper commands are given by the Range Officer.

18.10 Cease Firing - Competitors must obey this command immediately whether or not they have finished firing. Even though pressure has been applied to the trigger, pressure must be released so that the shot will not be fired.

18.11 Checking Scores - Competitors must check their scores promptly in the Preliminary Bulletin and call attention to errors within the time specified at that tournament. Failure to check scores within the challenge time limit forfeits the right to challenge.

18.12 Clearing the Firing Point - It is the competitor's duty to leave the firing point promptly at the conclusion of his/her relay. When leaving firing point, air rifles must be unloaded and actions open.

18.13 Checking the Bulletin Board - It is the duty of all competitors and coaches to check the Bulletin Board between matches. The Statistical Officer must be notified immediately of apparent errors. Official Bulletins must be checked and the Statistical Officer notified of any discrepancies between the Preliminary and Official Bulletins. Match Director's Bulletins on the Bulletin Board have the same effect as conditions printed in a program. It is the duty of competitors and coaches to familiarize themselves with all such Match Director's Bulletins.

18.15 Responsibility - It shall be the competitor's responsibility:

- (a) That all equipment meets all rules and match specifications in any match in which that equipment is to be used.
- (b) That competitor's position conforms to the rules.
- (c) That competitor has full knowledge of the rules under which the match is fired.
- (d) That after due warning of any infraction of existing rules, that competitor shall understand that a repetition thereof shall be the subject of disqualification for that match or tournament.
- (e) That when targets are framed by the competitor, the correct target for the range and position being fired is framed.
- (f) That his or her target is not altered intentionally or with special marks which benefit him in any way. Scores fired on such targets will be disqualified.

19. CLASSIFICATION

19.1 Classified Competitors - Are all individuals who are officially classified by the NRA for Precision Air Rifle competition, or who have a record of scores fired over courses of fire used for classification (See Rule 19.4) which have been recorded in a Score Record Book.

19.2 Unclassified Competitor - Is a competitor who does not have a current NRA classification, either regular or temporary by Score Record Book (Rule 19.14), nor an "Assigned Classification" (Rule 19.6). Such a competitor shall compete in the Master Class.

19.4 Scores Used for Individual Classification - Scores to be used for classification and reclassification will be those fired in individual and team matches in both indoor and outdoor NRA competition (except Postal Matches) over the following courses of fire and under the indicated conditions:

Precision Air Rifle: Individual 3-position.

Scores from Sanctioned Leagues (shoulder-to-shoulder or postal) may be recorded during the league firing season in Score Record Books but will only be used by the NRA Headquarters Office at the end of the league firing season for issue of Official Classification Cards.

Scores from "Finals" will not be used for classification.

19.4.1 Expanded Classification System for Juniors (Rule 2.3 only) -A match sponsor may use an expanded or different classification system for Junior shooters. Within that system, coaching may be allowed by the sponsor. However, the scores fired in classes that allow coaching will not be used for National Records or National standings, but shall be reported for NRA classification purposes.

19.5 Compilation of Scores for Position Air Rifle Classification Averages - Scores fired in complete matches over the above courses will be combined and averaged to establish a competitor's classification.

19.6 Assigned Classification - A competitor who has an earned classification (a classification obtained through a Score Record Book or an Official NRA Classification Card) for one type of competition in the grouping listed below will be assigned this same classification in any competition in which he does not already have an earned or assigned classification.

- (a) Indoor 4 Position
- (b) Outdoor 4-Position
- (c) NRA 3-Position Indoor
- (d) NRA 3-Position Outdoor
- (e) Outdoor Prone
- (f) High Power Rifle
- (g) International Smallbore Rifle (Indoor)
- (h) International Smallbore Rifle (Outdoor)
- (i) International Big Bore Rifle
- (j) International Prone
- (k) International Air Rifle
- (l) Precision Air Rifle

If the competitor has a classification in more than one type in the list, the higher classification shall be used. In

the second tournament in the new type, the competitor will use his Score Record Book rather than an assigned classification.

19.6.1 Score and Classification Falsification -No competitor will falsify score, or classification, nor that of any other competitor, nor be an accessory thereto.

19.7 Lack of Classification Evidence - It is the competitor's responsibility to have his NRA Official Classification Card or Score Record Book with required scores for temporary classification (Rules 19.1 and 19.14) and to present classification evidence when required. Any competitor who cannot present such evidence will fire in the Master Class. A competitor's classification will not change during a tournament. A competitor will enter a tournament under the correct classification and fire the entire tournament in that class. Should it be discovered during a tournament that a competitor has entered in a class lower than is appropriate, the tournament records will be corrected to show the correct classification for the entire tournament.

19.8 Competing In a Higher Class - Any individual or team may elect, before firing, to compete in a higher classification than the one in which classified. Such individual or team must fire in such higher class throughout the tournament and not revert to earned classification for any event in that tournament.

19.9 Obsolete Classifications and Scores - All classifications and scores (including temporary, Rule 19.14) except Master, shall become obsolete if the competitor does not fire in NRA competition at least once during 3 successive calendar years. Master classifications and scores shall become obsolete if the competitor does not fire in NRA competition at least once during 5 successive calendar years.

19.10 Appeals - Any competitor having reason to believe they are improperly classified may file an appeal with the NRA stating all essential facts. Such appeal will be reviewed by the NRA Protest Committee.

19.11 Protests -Any person who believes that another competitor has been improperly classified may file a protest with the NRA stating all essential facts. Such appeal will be reviewed by the NRA Protest Committee.

19.12 Team Classification - Teams are classified by computing the "team average" based on the classification of each firing member of the team. To compute this "team average" the key in Table No. 1 for the different classes will be used for both outdoor and indoor competition and the team total divided by the number of firing members of the team. Any fractional figure in the team average of one half or more will place the team in the next higher class. The "team average" will establish classification of a team as a unit but will not affect in any way the individual classification of team members.

TABLE NO. 1 - TEAM

Class	Key
Master	4
Expert	3
Sharpshooter	2
Marksman	1

19.13 Reporting Scores - NRA indoor and outdoor competition (See Rule 1.6) sponsors will report to the NRA all individual and fired team match scores fired over the courses stated in Rule 19.4. Scores will be reported as aggregate totals for all matches completed by a competitor. Scores will be reported by each sponsor no more than 30 days after the completion of the match and by each NRA Sanctioned League at the completion of the league schedule. The SR-1A Score Reporting Card will be used to report all scores.

19.14 Score Record Book (Temporary Classification) - A Score Record Book will be obtained by each unclassified competitor from the Official Referee, Supervisor, or tournament Statistical Office at time the competitor competes in his first tournament or from the Secretary of a Sanctioned League. He will record all scores fired by himself in all NRA competition (except Postal Matches) until such time as he receives his Official NRA Classification Card. The competitor will total all scores and divide that total by the number of 10-shot strings represented. The average so obtained will determine the competitor's NRA Classification at that time (See Rule 19.15 for average score for each classification).

Individual and team scores fired by the competitor during at least one tournament (Rule 1.1) or from the most

recent league match (Rule 1.6) must be posted in the Score Record Book to establish a temporary classification. The Score Record Book will be presented by the holder at all NRA competitions entered until the competitor's Official NRA Classification Card becomes effective.

NOTE: It is the competitor's responsibility to obtain the Score Record Book, enter scores and present it at each tournament until his Official NRA Classification Card becomes effective. When the NRA Classification Card becomes effective the Score Record Book becomes obsolete.

● **19.15 Individual Class Averages** - Competitors will be classified as follows and NRA Classification Cards issued accordingly:

PRECISION AIR RIFLE 3-POSITION

Master	97.00 and above
Expert	95.00 to 96.99
Sharpshooter	92.00 to 94.99
Marksman	91.99 and below

19.16 Establishing Classification - A competitor will be officially classified by the NRA when the total score for a minimum of 120 shots has been reported. However, classification averages will be computed only after the total score for a tournament or league has been posted and, therefore, the average may be based on a greater number of shots, but will not be based upon a lesser number. Total scores so reported to the NRA will be posted to the Classification Card for the competitor concerned. The scores for the stated minimum number of shots (or more if this minimum is reached during the scores of any tournament or league) have been posted so the average score per 10-shot string will be computed. The competitor will be sent an Official NRA Classification Card based on the averages so computed and according to the table in Rule 19.15. This classification will become effective the date shown on the card issued by the NRA.

19.17 Reclassification -A competitor who has been classified by the NRA will be reclassified as follows:

- (a) A record of all completed (See Rule 19.9) NRA Competition (except individual Postal Matches) scores fired by a classified competitor will be maintained in the NRA Headquarters.
- (b) A competitor will be considered for reclassification upward when his scores for not less than 120 shots, fired subsequent to the tournament date at which he earned his current classification, have been recorded as prescribed, except that such consideration will not include tournament or league scores until after all scores for the tournament or league competition concerned have been recorded. If his average score so justifies, he will be reclassified upward accordingly.
- (c) A competitor who believes his classification is too high may file a request with the NRA that his classification be lowered. Such a competitor must remain in the class concerned until a minimum 360 shots, fired subsequent to the effective date of his current classification have been recorded. When the average of such shots places the competitor in a lower class, he will be reclassified accordingly. When a competitor has been so classified downward, and by scores fired in NRA competition (except NRA Postal Matches) has again earned his former classification, such classification shall become final and the competitor shall retain the earned classification until reclassified into a higher class as outlined in paragraph (b).
- (d) A reclassified competitor shall be sent a new classification card which will become effective on date shown on card issued by NRA.

20. NRA OFFICIAL REFEREE

20.1 Eligibility - Any individual, 21 years of age or older fulfilling the requirements currently in effect may be certified as an Official Referee.

20.2 Certification -

- (a) To be certified as an Official Referee applicants must undertake such oral, written, or practical examinations as the Association may require. Note: The Board of Directors of the Association will be the final judge as to the applicant's fitness for certification. Certification may be refused without stating cause.
- (b) Certificates will remain in force for such periods as may be indicated on the face thereof. Certificates may be surrendered by the holder or cancelled by the Association at any time without stating a cause.
- (c) Re-examination may be required at any time to determine the Official Referee's current ability to meet the requirements.
- (d) Official Referees may be authorized to serve with certain limitations specified for their authorization. Such limitation may be:
 - For a limited time only, or
 - For special tournament or tournaments, or
 - With specified territorial boundaries, or
 - For specified typed of competition or classes or tournaments.
- (e) Insignia remain the property of the Association and must be returned at the termination of the Official Referee's certification.

20.3 Duties - General

- (a) It is the duty of the Official Referee at all times to keep informed of NRA Bylaws, current competitive Rules, and match administrative procedures. He must be equipped to act as guide and counselor to every official at a tournament both on the range and in the Statistical Office.
- (b) He must be familiar with the various NRA qualification courses and with National Classification Rules.
- (c) He must know the requirements for individual membership in the Association and the general requirements for club affiliation.
- (d) It is his duty to report to National Headquarters any suggestions, criticisms, incidents or trends which, in his opinion, should be considered by the Association in order to promote the best interests of shooting.
- (e) He must at all times and under all circumstances remember that his value as an Official Referee is in direct ratio to his reputation for integrity, impartiality, broad knowledge of the game, courtesy, courage and sobriety. The use of alcoholic beverages while on duty cannot be condoned and their excessive use at any time will be sufficient cause for cancellation of the Official Referee's Certificate.

● 20.4 Duties - Before Tournament

Having accepted an assignment to serve, it is the duty of the Official Referee to:

- (a) To be Familiar with the program.
- (b) Verify, by mail or in person with the Match Director of the tournament to ensure that range and statistical facilities are adequate and in good order and that ample range and statistical personnel have been employed or definitely arranged for.

● 20.5 Duties - During Tournament

- (a) Observing the functions of the Statistical Office when first opened to help establish proper registration and squadding procedure. Make sure the Statistical Office has arranged to check all competitors' current classifications before issuing a competitor's first squadding ticket.
- (b) Inspecting the target equipment and range personnel in company with the Match Director to ensure that the range will function properly.
- (c) Consult with the Match Director and arrange to have Official Bulletins posted immediately covering any changes or corrections which have been authorized.
- (d) Observe personally the scoring and bulletin methods used when the targets from the first relay are being scored and call attention to any errors before an erroneous method becomes established.
- (e) Remain constantly alert for infractions of safety or competition Rules by moving over the range behind the firing line from flank to flank; observe activities of target runners, Range Officers, scorers, and statistical clerks, spectators; watch competitors handle their rifles, etc.
- (f) Report immediately to the Match Director any errors in administration or infractions of Rules by competitors or personnel, requesting that he have them corrected at once. If the matter is one requiring instant action the Official Referee should direct whatever action is required and report his action and the reason to the Match Director as soon as that officer can be reached.
- (g) In tournaments when situations occur that are not specifically covered by an existing Rule or Rules, the Referee shall exercise his best judgment in ruling for the best interest of the shooting sports and competitors.
- (h) Check personally with the Statistical Officer at the conclusion of the tournament to make sure that all bulletins have been properly completed and awards issued as prescribed in the Tournament Program or are available for mailing to competitors who have left the range.
- (i) Forward to NRA Headquarters all reports currently required of him, including National Record Reporting forms, copies of protests, decisions, appeals and all written statements bearing on the case.

20.6 Handling of Challenges and Protests - Challenges and protests will be handled in the manner provided in these Rules. (See Sec. 16).

20.7 Assignment to Tournaments - Official Referees are assigned to tournaments by the NRA Headquarters Office.

20.8 Official Referee as Competitor - No Official Referee may compete in any match fired in conjunction with any tournament where he is officiating.

20.9 Status of the NRA Official Referee -

- (a) The Official Referee will not give directions to the tournament operating personnel except through the Match Director. In the event of a disagreement between Match Officials, the Official Referee shall prevail at the match with recourse only to the Protest Committee. In all emergency cases involving the safety of personnel or property, the Official Referee will act immediately and forcefully, taking full responsibility and reporting his action to the Match Director and to the National Rifle Association when making his tournament report.
- (b) The Official Referee is a representative of the National Rifle Association present at a tournament to interpret the Rules and Regulations for the benefit of both the Tournament Officials and the competitors. It is his duty to see that all Rules and Regulations are properly and efficiently enforced. He is not responsible for the actual administration and conduct of the tournament except to enforce the Rules and Regulations. It is his duty to make such suggestions and recommendations as are necessary to enable the tournament staff to operate in the most satisfactory manner.

Precision Air Rifle Position illustrations

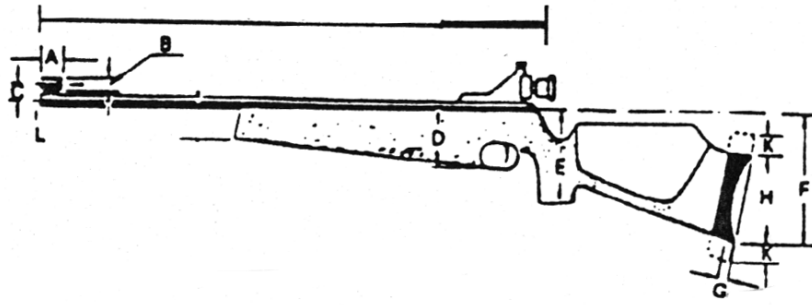

Side View

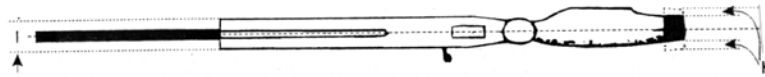

Bottom View

Figure 1

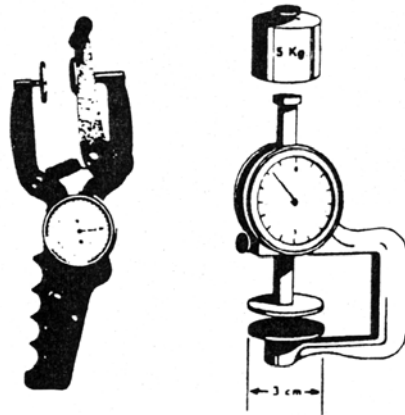
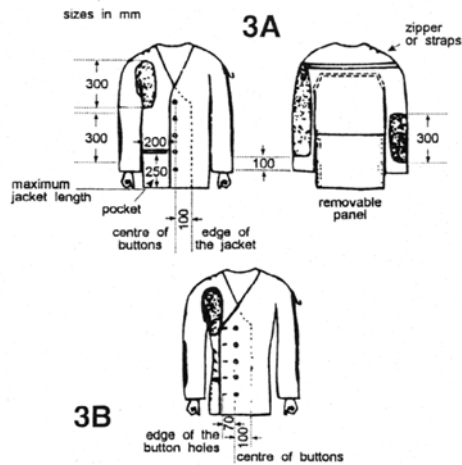

Figure 2 Sample Measuring Devices for measuring all articles of clothing



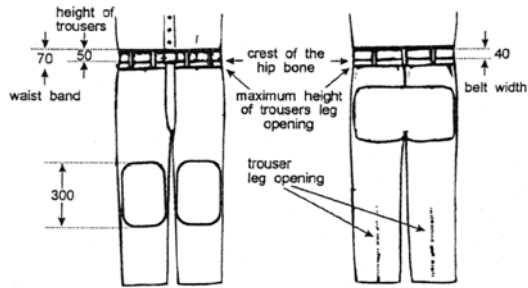

Figure 3C - Shooting Trousers

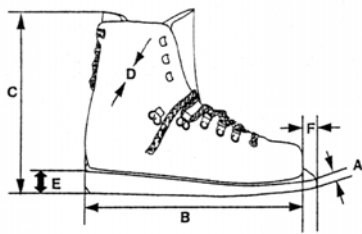

Figure 4 - Shooting Shoes

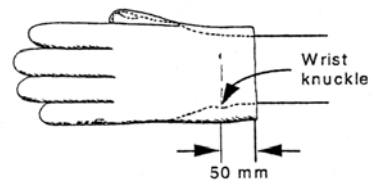

Figure 5 - Shooting Glove

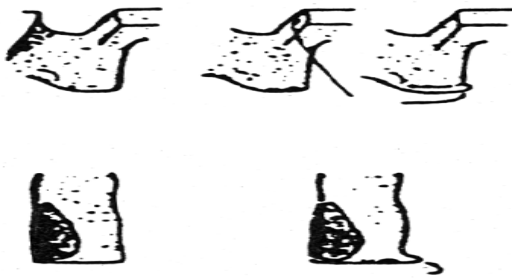

Figure 6 - Heel Rest



Prone



Kneeling



Standing

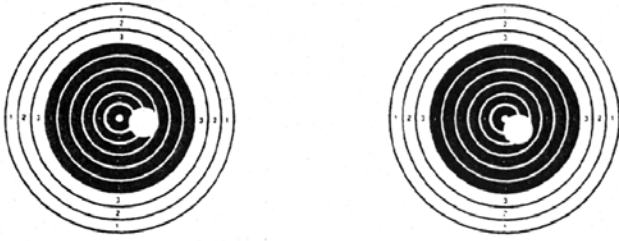

Figure 7 - Correct method of INSIDE scoring
The shot on the left counts 7, the one on the right, 8

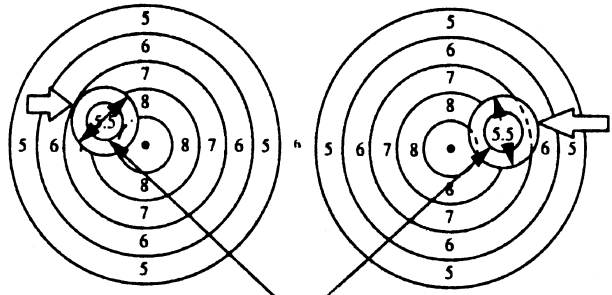

Figure 8a - Correct use of OUTWARD Scoring Gauge
The shot on the left counts 9, the one on the right, 8

**APPENDIX
NRA COMPETITION TOURNAMENT PROGRAMS**

Note: The program for tournaments must describe the condition of the match, the positions, rifle, caliber of rifle, ammunition, target, range, and should cover all the following points:

TOURNAMENT NAME: Do not designate "State Championship" unless authorized by the State Association: "District" or "Regional Championship" unless authorized by NRA.

TOURNAMENT DATE(S): Date or dates of tournament.

SPONSORING ORGANIZATION: Name of Club or Association.

FOR INFORMATION CONCERNING TOURNAMENT WRITE TO: Give name and complete address as you want it listed in Coming Events Notice.

DIRECTIONS TO RANGE: List directions clearly.

RULES: The Statement that "NRA Rules shall govern" will allow the most liberal conditions found in those Rules.

COMPETITION OPEN TO: Indicate eligibility requirements. See Rules 1.7 (c) and 1.7 (d). (Tournament sponsors may restrict competition to residents of certain areas; members of certain groups; competitors in certain classification groups, etc., provided such restriction is plainly stated in program.)

REGISTRATION FEE: List amount of tournament registration to be charged each competitor, and what it entitles him to (brassard, competitor number badge, etc., and a copy of the Official Bulletin).

ENTRIES: List name and address of the person to whom entries should be mailed.

ENTRY FEE: State amount per match (team and individual).

ENTRIES CLOSE: State date and time.

POST ENTRIES: Show that Post Entries will or will not be accepted, closing time and fee.

ENTRY LIMIT: State number of entries that will be accepted.

FIRING STARTS: State hour first relay of first match will begin each day.

CLASSIFICATION OF COMPETITORS: See General Regulations. If NRA Classification System is not used or if classes are combined, list details.

AWARDS: List schedule of awards for individual and team matches.

MATCH SCHEDULE AND CONDITIONS: Give complete details of course of fire, type of sights, rifle or pistol, caliber of firearm, etc.

GENERAL INFORMATION: List eating facilities, housing facilities, etc.

GENERAL REGULATIONS FOR NRA SANCTIONED TOURNAMENTS

Tournament sponsors must follow these Regulations as directed by Rule 1.4. They provide standard procedures required for the sanctioning of NRA Tournaments, establishing of fee structures, awards, reporting, cancellation, NRA membership requirements, and other items involved with NRA Sanctioned Tournaments, both Registered and Approved.

A. GENERAL REGULATIONS GOVERNING NRA APPROVED TOURNAMENTS

1. SANCTION OF NRA APPROVED TOURNAMENT(S): To obtain approval of tournaments, the following steps must be taken by the sponsoring organization in advance of the tournament date.

- a. Send NRA your completed applications and draft copies of your completed programs a minimum of 30 days in advance of the tournament date.
- b. If the above is not done, the NRA reserves the right to cancel its sanction of the tournament.
- c. In order to be listed once in the Coming Events section of Shooting Sports USA, your application and programs must be received by the Competitions Division by the 15th of the month, three months prior to the month of issue. If you desire publicity in more than one issue, an additional month's notice must be allowed for each monthly listing.

2. GRANTING OF "APPROVED" SANCTION: As soon as the tournament is granted Approved sanction, one copy of the signed application, an Official Sanction Poster, and a corrected (if necessary) copy of the draft program will be returned to the sponsor. These items provide the authority to the sponsor to conduct the tournament. All changes and information provided in the approved draft program must appear in the final printed program. No major changes in course of fire, number of matches, etc., may be made unless NRA is notified. This may be done in writing if time permits, or by including a copy of the Match Director's Bulletin (which makes the changes) with the final results of the tournament.

3. TOURNAMENT CANCELLATION: If a tournament is cancelled, NRA must be notified immediately.

4. CLASSIFICATION OF COMPETITORS: The NRA Classification System may be used but is not required.

5. COURSES OF FIRE IN APPROVED TOURNAMENTS, FOR CLASSIFICATION USE: Courses of fire which may be used for classification are listed in Rule 19.4. It is not required that these specific courses of fire be used in Approved Tournaments, but if the scores are to be used for classification, they must be used.

6. AWARDS: All awards are furnished by the sponsor. The minimum award schedule must include only the Tournament Winner, that person/team firing the highest score regardless of classification or category.

7. ENTRY FEES:

- a. NRA Registration Fee: A fee of \$4.50 per competitor is charged by NRA for Approved Tournaments.
- b. Sponsor Entry Fees: The amount of these fees is determined by the Sponsor, and must be stated in the program separately from the NRA Registration Fee.

8. TOURNAMENT OFFICIALS AS COMPETITORS: All Officials of an NRA Approved Tournament (except Supervisors) may compete in that tournament.

9. NRA MEMBERSHIP: NRA membership is not required for participation in NRA Approved Tournaments. However, sponsors may elect to restrict those persons entering the tournament to NRA members only, if they wish to do so.

10. REPORTS TO NRA: The Match Director is responsible for making certain that the following reports are forwarded to NRA within 30 days of firing. See Rule 19.13.

- a. An SR-1 (Conventional) card for each competitor showing the total number of shots fired in individual

matches and a total score; the total number of shots fired in Fired Team Matches, and the total score of the fired team match(es), The NRA membership ID number, if applicable, must be indicated on each card for classified competitors and NRA members who are not yet classified. Score Reporting cards are available free of charge upon request in packs of 50.

- b. A Registration Fee Reporting Form, and remittance of \$4.50 per competitor.
- c. A copy of any special Match Director's Bulletins.

B. GENERAL REGULATIONS GOVERNING NRA REGISTERED TOURNAMENTS

The following regulations are established to provide standard procedures for all registered tournaments except Regional, Sectional, and National Championships. State Championships MUST be approved and recognized by the State Association (Rule 1.6).

1. SANCTION OF NRA REGISTERED TOURNAMENT(S): To obtain approval of tournaments, the following steps must be taken by the sponsoring organization in advance of the tournament date.

- a. Send NRA your completed applications and draft copies of your completed programs a minimum of 45 days in advance of the tournament date.
- b. If the above is not done, the NRA reserves the right to cancel its sanction of the tournament.
- c. In order to be listed once in the Coming Events section of *Shooting Sports USA*, your applications and programs must be received by the Competitions Division by the 15th of the month, three months before the month of issue. If you desire publicity in more than one issue an additional month's notice must be allowed for each monthly listing. If applicants and programs are received after the 90 day period, no notice will appear in *Shooting Sports USA*.

2. GRANTING OF "REGISTERED" SANCTION: As soon as a tournament is granted Registered sanction, one copy of the signed application, program, and Official Sanction Poster will be returned to the sponsor. In cases where a Referee is assigned, the Official Poster will be mailed after the Referee assignment is made, and the sponsor will be notified of the identity of the Referee at the same time. All changes and information provided in the approved draft program must appear in the final printed program. No major changes such as courses of fire, number of matches, etc., may be made unless NRA is notified. This may be done in writing if time permits, or by including a copy of the Match Director's Bulletin (which makes the changes) with the final results of the tournament.

3. TOURNAMENT CANCELLATION: If a tournament is cancelled, NRA must be notified immediately. Note: UPON CANCELLATION OF A TOURNAMENT, IT IS ENTIRELY POSSIBLE THAT THE *Shooting Sports USA* LISTING WILL CONTINUE FOR ONE MONTH. IT IS NOT POSSIBLE TO REMOVE A TOURNAMENT FROM THE LISTING AFTER IT HAS BEEN SUBMITTED TO THE PRINTER.

4. CLASSIFICATION OF COMPETITORS: The NRA classification or category system must be used in Registered Tournaments. Sponsors may use an expanded classification system when large numbers of marksman or unclassified competitors are entered. (Samples available from NRA.)

5. COURSES OF FIRE IN REGISTERED TOURNAMENTS, NATIONAL RECORDS AND CLASSIFICATIONS: National Records may be set only in Registered Tournaments using courses of fire specified in Rule 17.5. Courses of fire which are used for classification are specified in Rule 19.4.

6. AWARDS: All awards are furnished by the sponsor. In Registered Tournaments, the minimum award schedule must consist of the following:

- a. *Individual Match Awards Required:*
 - 1. **Winner** in each individual fired match and in each aggregate, awarded to the competitor with the highest total score. Match winners may not receive a class award, but must be counted in with other members of that class to determine the number of class awards.

2. **High Scoring Competitor** in each class in each match. Classes may be combined because of low entry, but the manner in which such combinations are made must clearly be stated in the program.

b. *Team Awards Required:* (If there are team matches in the program) Winning Team of each team match is the team firing the highest total score in the match.

7. ENTRY FEES:

a. NRA Registration Fee: A fee of \$5.50 per competitor is charged by NRA for Approved Tournaments.

b. Sponsor Entry Fees: The amount of these fees is determined by the Sponsor, and must be stated in the program separately from the NRA Registration Fee.

8. TOURNAMENT OFFICIALS AS COMPETITORS: The Match Director, Deputy Match Director, Chief Range Officer, Chief Statistical Officer, and Chief Pit Officer (where applicable) should NOT compete in a tournament at which they are officiating. Rule 11 covers specific duties of Tournament Officials.

9. NRA REFEREE: An NRA Official Referee may be assigned by NRA to all State, Sectional, and National Championships. When a Referee is not present the Match Director will appoint a 3-member Jury.

10. NRA MEMBERSHIP: NRA membership is encouraged but not required of all competitors in a Registered Tournament,. Sponsors may accept NRA membership applications and fees from non-members who wish to join the NRA.

11. REPORTS TO NRA: The Match Director is responsible for making certain that the following reports are forwarded to NRA within 30 days of firing. See Rule 19.13.

(a) An SR-1 (Conventional) card for each competitor showing the total number of shots fired in individual matches and a total score, the total number of shots fired in Fired Team Matches, and the total score of the fired team match(es). The NRA membership ID number, if applicable, must be indicated on each card. Score Reporting cards are available free of charge upon request in packs of 50.

(b) A Registration Fee Reporting Form, and remittance of \$5.50 per competitor.

(c) A copy of any special Match Director's Bulletins.

(d) A completed National Record Reporting form, even if no National Records were set.

(e) Two completed sets of "Official Final Results Bulletin of Standings" for the tournament.

12. FINAL RESULTS BULLETIN: A copy of the Official FINAL RESULTS BULLETIN must be sent within 30 days to each competitor participating in the tournament.

NOTE: The requirement to get the Final Results Bulletin to competitors within 30 days may be met by posting the results on an internet web site, provided competitors can download and/or print a paper copy. Sponsors who post electronic results will provide the competitors with the web site address and must provide a paper copy to competitors upon request.

GLOSSARY

Rifle shooting, like other sports, has its own language - technical terms, slang and idioms. Many of the words and expressions used in these Official Regulations are defined as part of the Rules. The following explanations are given for the benefit of the tyro to help him/her understand the Regulations.

Backer (Backing Target) - A blank paper of target size and material positioned behind the record target. The backer is used to detect crossfires, excess hits and to verify, when required, the number of record shots fired on the target.

Bullseye - An aiming point printed on a target card. The aiming point for shooting is usually circular and contains concentric numbered rings for scoring purposes.

Category - A grouping of individuals designated by a specific title in a tournament program to establish a system of competing for awards. Those groupings may be used within a classification, or in some circumstances, instead of classification. (Examples: Junior, Senior, Military, Collegiate, etc.)

Classification - The grouping of individuals by averaging a number of match scores. Classifications are designed to have individuals compete for awards against others of similar competitive skill levels.

Entry - The act of declaring intent to shoot in a match and the paying of the required fee to the proper official in accordance with the program for such match.

Framing (Mounting) Targets - A term used to describe the act of placing targets on the mounting ready for firing.

Home Range Matches - Same as Postal Matches.

Match - A complete event as indicated in the program for the issuance of certain specific awards. A match may consist of one or of several stages. It may, in the case of aggregate matches, include the scores in several subsidiary matches.

Members of the National Rifle Association - Any individual member including Benefactors, Patrons, Endowment, Life, Annual, Associate, Non-Resident and Junior members.

Non-U.S. Citizens - Non-U.S. Citizens who are also Non-Residents, who are not members of the National Rifle Association of America, but who are members in good standing of their own National Associations or Federations, and have adequate proof of such membership in hand, may compete in any NRA Sanctioned Tournament, unless further restrictions are imposed by conditions stated in the program.

Post Entry - An entry made after the regular entry closing time. Because of the extra work placed on the Statistical Office as a result of late entries, an additional fee is charged (the "Post Entry Fee"). Sometimes no post entries are accepted. "Post Entries" have no connection with "Postal Matches."

Postal Match - A match in which competitors fire on their home ranges using targets which have been marked for proper identification. Fired targets and/or scores are then exchanged by mail.

Score - The total value of all required shots fired by a competitor in any one match.

Sighting Shots - Shots fired at a target provided for that purpose and used to obtain desired information relative to adjustment of sights for the match which immediately follows.

String - A series of shots (usually 5 or 10 shots) forming a part of a "stage."

Stage - In a match fired at more than one range or in more than one position, each range or position is referred to as a "stage" of the match.

Target - A surface, usually paper or tagboard, containing one or more aiming points which is frequently called a target card.

NRA QUALIFICATION SHOOTING

Shooters always like some means by which they can measure their ability and progress. Whether the shooting is done at home, at the club range or in a tournament, there is greater satisfaction in achieving a previously set goal than in just practicing. There are qualification courses for many types of shooting with fine awards within the reach of every shooter.

For specific information, direct your questions to the NRA Education and Training Division, 11250 Waples Mill Rd., Fairfax, VA 22030.